

Nº 8 | 2024

www.shipandoffshore.net

SMM issue

Special
ENERGY at SEA
included

Ammonia as future fuel: Benefits and disadvantages 10

3D ship models: How automated processes facilitate shipbuilding 18

FuelEU Maritime: Baselines, incentives, penalties and compliance 92

Ship and Offshore Repair Journal included

Ship & Offshore

THE INTERNATIONAL PUBLICATION FOR OFFSHORE & MARINE TECHNOLOGY



the cylinder pressure people

EPM-Peak EPM-XP EPM-XPplus EPM-XPplus-vibro

EPM Next Generation
4 different EPM types - only one device



- simple online upgrade from peak pressure indicator EPM-Peak up to engine analyser EPM-XPplus-vibro via web
- one EPM visualisation software
- online software and firmware updates
- two additional function keys for an easier menu handling
- a larger and more comprehensive display

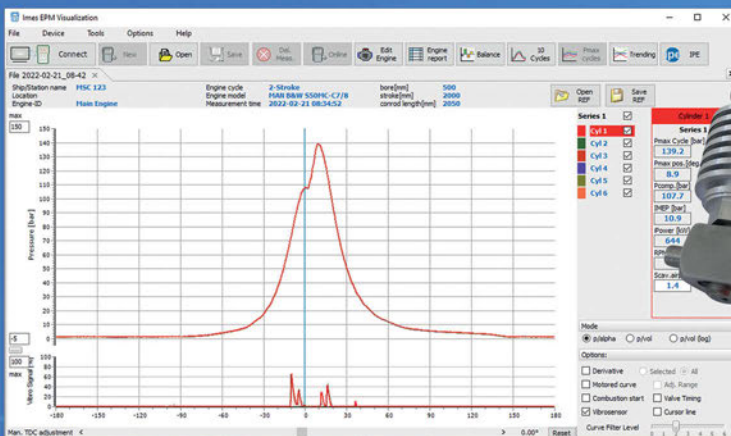

- automatic Pcomp and IPOWER calculation without TDC sensor
- professional visualisation software for optimising engine operation
- direct data transfer to IPE - IMES Performance Evaluation software
- more than 20 hours battery capacity

www.imes.de





Meet us
in Hall A3
Stand A3.301

MAN Energy Solutions
Future in the making



Moving big things to zero

**with future-proof
retrofit solutions**

We're enabling long-term sustainability

Balancing decarbonization, availability, and economics is a challenge for energy-intensive sectors like power generation, shipping, and process industries. Retrofits are one of the most effective ways to achieve net-zero targets. Our experts convert your conventional fuel engines into dual fuel systems that can also run on green e-fuels. By upgrading existing engines and turbomachinery, we balance ecology and economy, and give your business a long, clean future.



Kathrin Lau
Editor in Chief
kathrin.lau@dvvmedia.com

Changing course

The search for good news – in business, society or geopolitics – is often rather disillusioning. The catastrophic reports from war and crisis-hit regions weigh too heavily, concerns about deepening economic downturns are too great.

The search for good news is by no means a childish naivety; after months, even years of shattering and far-reaching incidents, it is more a need for normality and peace. Normality and peace, which are necessary to pursue efficient business, the important tasks. Acting instead of reacting; creating instead of fighting fires. At the time of writing, stock markets around the world have not fully recovered from a deep downturn. Concerns about the US economy, in particular, have reverberated around the world. Uncertainties have been magnified by regional conflicts, interruptions to supply chains, and the implications for the global economy as a whole. Political uncertainties come on top, making investors even more nervous.

Experts, however, speak of a course correction rather than a crash. Sharp rises on stock markets over the past few months have not always been underpinned by real economic development, they say. A recession is therefore unlikely, but the risks are increasing. The first positive reports of rising incoming orders, for example in German industry, allow us to breathe a tentative sigh of relief.

The past months and years have once again made us painfully aware that many things we have taken for granted are fragile and volatile. The maritime economy – with its series of vital global supply chains – has been dramatically affected, and there is little chance of an early resolution on this. The most obvious example is the conflict in the Middle East, which appears to be deepening, and has prevented normal route planning through the Red Sea for many months.

The maritime sector is remarkably resilient, however. The industry has always adapted, found solutions and continued to develop, both technologically and in terms of crewing, despite its sometimes somewhat unjustifiable dusty image.

The upcoming SMM in Hamburg will once again bear witness to this. The global industry will be meeting in Hamburg for the 31st time to network, exchange ideas and, of course, present and explore new products and technologies.

Major topics will continue to be the increasingly urgent decarbonisation of shipping, combined with a sustainable increase in efficiency and a competitive positioning in the international markets. And as always, the show in Hamburg will also put further and emerging relevant topics such as artificial intelligence and the repair and retrofitting business in focus.

All in all, we are confident that this year's SMM will – even in a time like this – prove that the industry is well positioned to weather current and future “storms” – despite the sometimes devastating conditions in the world.

Just like any other situation in life it shows that we may not be able to change the direction of the wind, but we can adjust the sails and alter our course in order to react to our environment.

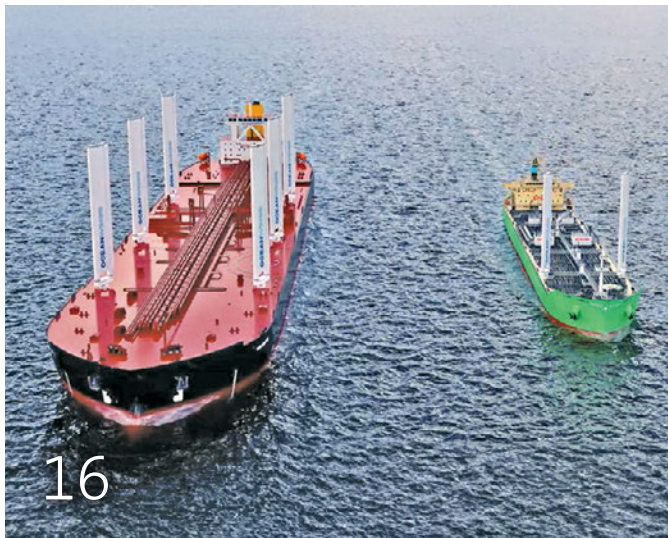

16



74

Shipbuilding & Equipment

- Future Fuels & Energy Solutions
- 10 Advantages and disadvantages of the ammonia power start-up
- 12 Methane abatement gathers momentum as initiative grows
- 14 Accelerating the shipping energy transition
- 16 Rebranded OceanWings expands sail portfolio
- 16 Ammonia research project on performance and safety

Digitalisation

- 18 Automation ready for a great leap forward

Shipbuilding & Equipment

- Industry News
- 20 DNV launches new in-operation class notations
- 21 Combined engine gets EU certification
- 21 Partnership accelerates landing craft development

Offshore & Marine Technology

- Industry News
- 74 More marine energy support required
- 74 Two-session conference

Ship Operation

Green Shipping

- 90 A “varying degree of preparedness”
- 92 FuelEU Maritime: baselines, incentives, penalties and compliance
- 94 Emissions monitoring system now integrated with Veracity
- 94 Shippers offered book-and-claim sustainable fuel option

Condition-Based Maintenance

- 95 Latest analytical models deliver substantial benefits

Navigation & Communication

- 96 New antenna ensures uninterrupted service
- 96 AI functionality added to voyage optimisation platform
- 98 Speed routing service launched
- 98 Tie-up for better procurement

- Complete Filters
- Filter Elements
- Spare Parts
- Accessories
- Centrifuges
- Cleaning Agents
- Repair
- Installation

The Specialists for Filters in Marine and Industry



As a filter-specialist, **FIL-TEC RIXEN GmbH** focuses for more than 35 years on the improvement, production, service, and sale of filters and their spare parts for the **marine- and industrial sector**.

We supply filter elements and spare parts for single-, duplex-, and automatic filters for lubricating oil, fuel oil, hydraulic oil, water, and air of all well-known manufacturers (e.g. Boll & Kirch),



as well as **replacements** for Filtrex, Moatti, Nantong, and Kanagawa Kiki.

As a **distribution partner** we supply replacement- and original filter elements of the brand of



SMM 2024
3 – 6 Sep 2024
Hall A1 Stand 235

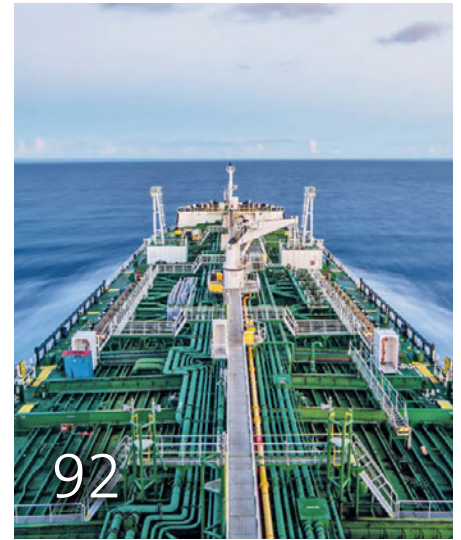

In Focus: SMM 2024

The world's leading trade fair and conference event for the maritime industry, SMM 2024 will bring together about 40,000 participants from over 120 countries and serve as a unique platform for business, the exchange of ideas and cooperation.

On the exhibition floor, more than 2,000 companies will present state-of-the-art technologies and services.

The SMM feature with exhibitors' previews starts on page 23

Schiff & Hafen | Ship & Offshore
Visit us at SMM 2024 Hall A1 Stand 529

Regulars

- 3 Comment
- 6 News & Facts
- 22 New Ships
- 99 Imprint



Special ENERGY at SEA and Ship and Offshore Repair Journal included

Quality Media for Maritime Experts





The *Spirit of Tasmania V* was recently launched in Finland

Source: RMC

Rauma launches second ferry for Tasmania

Spirit of Tasmania V | The second ferry being built for TT-Line Company Pty Ltd, also known by its trading name Spirit of Tasmania, has been launched at Rauma Marine Constructions (RMC) in Finland. The *Spirit of Tasmania V* follows the launch and naming of *Spirit of Tasmania IV* last October and that vessel will be delivered in August. The second ferry is due for completion early next year.

The vessels, which are significantly larger than their predecessors, have been designed to carry cars and passengers between Geelong, near Melbourne in Australia, and Devonport in Tasmania. The route across the Bass Strait is known for its challenging conditions.

Mika Nieminen, CEO and president of RMC,

commented: “The Spirit of Tasmania vessels are specifically designed for this route and its demanding sea conditions. Our shipyard is known for our ability and expertise to customise ships to meet the high standards and quality requirements of our clients. I am extremely proud of the progress in the construction of these vessels. The project we are delivering for TT-Line Company is also nationally significant as it is one of the largest individual export deals between Australia and Finland.”

RMC, which is celebrating its tenth anniversary this year, currently has three ships under construction. Alongside the Spirit of Tasmania ferries, the yard is building the first multi-role corvette for the Finnish Navy in its dedicated multi-role hall.

Engine de-rating a success

Car carrier | Höegh Autoliners, Accelleron, and Hanwha Engine have completed a project to undertake engine part-load optimisation (EPLO) on board the 2006-built pure car truck carrier, *Höegh Detroit*. The success of the project will lead to similar EPLO modifications on board seven more vessels in the company’s fleet.

With fuel savings of 10g/kWh, equivalent to about 5%, the 7,850-CEU vessel will now use significantly less fuel, saving money and boosting its carbon intensity indicator (CII) ratings. The modification will also reduce the company’s exposure to the EU Emissions Trading System through lower emissions.

Part of the project involved the installation of a new propeller. This enables the vessel to sustain the same service speed and lose no time, the Oslo-based vehicle carrier specialist said.



The new bulker design is set to achieve tangible fuel savings

Fuel-efficient bulker design

Kamsarmax | Kongsberg Maritime has unveiled what it calls a ‘Super-Efficient Bulker’ vessel concept. Together with Finnish Deltamarin, it has developed a vessel design that aims to demonstrate that compliance with future regulations is possible even when using

conventional fuels. For the initial study, Kongsberg Maritime selected a Kamsarmax bulker of 82,000dwt as the basis. The vessel concept features several fuel-saving, efficiency-enhancing technologies, including rotor sails and suction wing sails and an innovative hull form.

UHL Fable christened in Hamburg

United Group | Germany’s United Heavy Lift (UHL), part of the Hamburg-based United Group, has named its latest multi-purpose heavy-lift vessel, *UHL Fable*, in a ceremony at the Baakenhöft Terminal near the Elbphilharmonie concert hall in the Port of Hamburg.

The ceremony took place following completion of the 13,402dwt vessel’s maiden voyage from CSSC Hudong Shipyard in Shanghai. The new ship, number 19 in UHL’s F900 Eco-Lifter series, transported its first cargo of onshore rotor blades for Danish wind energy company, Vestas Wind Systems. Vessels in this class have a range of sustainable features including an IMO Tier III-certified main engine from which 95% of

NOx emissions are washed out. Diesel particles are burnt off in catalytic converters. The vessel has two cranes of 450 tonnes safe working load.

The economical *UHL Fable* burns ten tonnes of fuel at 12 knots and 21 tonnes at 15 knots. Like its sister vessel, *UHL Fresh*, the ship can use biodiesel.



UHL Fable in front of Hamburg’s Elbphilharmonie Source: UHL

15-MW turbines off Scottish coast

Contract | Denmark-headquartered Cadeler, which operates the world's largest fleet of jack-up offshore wind installation vessels, has won a contract to install 72 large turbines at Scotland's *Inch Cape Offshore Wind Farm* using one of its new M-class wind turbine installation vessels.



Source: Cadeler

Cadeler will use one of its newbuild M-class installation vessels on the project

The project, worth between EUR 114-130 million and due to start in the fourth quarter of 2026, will take place at the wind farm about 15km off the east coast of Scotland. When the 15-MW turbines are fully deployed at the end of the installation phase lasting about 250 days, the facility will be capable of generating sufficient electricity to supply about 1.6 million UK households.

Mikkel Gleerup, CEO of Cadeler, commented: "With the recent renewal and continuing expansion of our fleet of jack-up offshore wind installation vessels – the industry's largest – Cadeler is ready to meet the fast-growing and dynamic market demand."



Rendering of the new tanker design

Source: GEFO

Wind-ready chemical tankers ordered

GEFO | Two 7,900dwt chemical carriers with stainless steel tanks have been ordered by Hamburg-based GEFO Shipping Group at Nantong Xianhyu Shipyard in China. The two vessels have been designed 'ready' for the installation of Flettner rotor wind sails and possible conversion to methanol propulsion in the future. The shipyard contract

contains options for two more vessels.

The chemical tankers will have ice class 1A, with hulls optimised for the demanding weather conditions that often prevail in the North and Baltic Seas. The output of the main engines has been reduced, the company said, thereby facilitating operation in the most economical speed range.

Offshore charging concept for CTVs

Electrification | Damen Shipyards Group has developed a new concept for offshore charging, offering a way to reduce emissions during the operational phase of an offshore wind farm. The system envisages a fully electric crew transfer vessel (CTV), which can charge at either a turbine or one of Damen's commissioning service operations vessels (CSOVs) fitted with a charger. With the infrastructure for turbine-mounted chargers not yet widely available, vessel-to-vessel charging offers CTV owners and operators an opportunity to invest in the sustainable technology of the future, at the present time, as Mark Couwenberg, product manager of Service Operations Vessels at Damen, explained. "Offshore charging is an essential feature for a fully electric CTV operation. Typically, this would be dependent on the charging infrastructure being present at an offshore



The CTV can either charge at a turbine or at one of Damen's CSOVs outfitted with a charger

Source: Damen

wind farm. Our unique position as builders of both CTVs and CSOVs led us to the idea of placing the charging scope within our assets. This can be done with either a conventional, diesel-powered CSOV or a fully electric version. Of course, from an emissions' reduction perspective, the latter is the more preferable option. However, such a solution makes it possible for CTV operators to invest today, in preparation for the wider dis-

tribution of full electric CSOVs tomorrow. We believe this could give a considerable boost to the maritime energy transition."

Installing a large battery system on board a CTV is a challenge, given the weight and space restrictions. Couwenberg said that installing the system on the much larger, less space-sensitive CSOV gives the smaller vessel access to the energy it requires without compromising on capabilities.

New company founded

Offshore wind deployment | A newly established company, Maersk Offshore Wind, will provide the sector with a new system to save installation time and cut costs. The first of a new generation of wind installation vessels (WIVs) is due for delivery next year and is expected to reduce installation time by about 30%. The move is necessary, Maersk said, because offshore wind deployment needs to speed up to meet ambitious targets in the EU and the US. The two regions have a total installed capacity target of 90 GW by 2030.



Source: Maersk Supply Service

The new generation of WIVs are expected to reduce installation time by about 30%

US-built crew transfer vessels fleet grows



The four newbuildings are *Windea Courageous*, *Intrepid*, *Ranger* and *Enterprise*, all named after America's Cup sailing yachts Source: Windea

Commissioning | A fleet of four crew transfer vessels (CTV) has been commissioned by Windea CTV LLC, a joint venture between MidOcean Wind LLC

and Hornblower Group in the United States. The four vessels, the nation's largest fleet of purpose-built CTVs, have been built in domestic shipyards and

will be manned by American seafarers. The 30m-long hybrid-ready CTVs were built to an Incat Crowther design at St. Johns Ship Building in Florida, and Gulf Craft and Breaux Brothers Enterprises, both in Louisiana. The four ships include the *Windea Courageous* and *Windea Intrepid*, delivered some time ago, as well as the *Windea Ranger* and the *Windea Enterprise*. They will work on offshore wind projects on the US east coast. The *Enterprise* will be deployed alongside the *Courageous* and *Intrepid* in New Bedford and Martha's Vineyard, Massachusetts, while the *Ranger* will work in Norfolk, Virginia. A fifth vessel will join the *Ranger* early next year.

Short-sea cargo ship launched

Vertom Lisa | A single-hold 7,280dwt short-sea cargo ship has been launched and named at Thecla Bodewes Shipyards in the Netherlands. Number six in a series of ten, the *Vertom Lisa* is the latest addition to the Vertom Group's fleet. The Rhoon-based owner operates a fleet of more than a hundred vessels ranging size from 1,500dwt to 12,000dwt.

The *Vertom Lisa*, built to a Labrax-design, has a range of features boosting sustainability.

With a hold capacity of 329,700ft³, the 119m-long vessel's hull has been optimised using computational fluid dynamics.

Optimisation project completed

OSVs | Marseille-based companies, Bourbon Offshore and Opsealog, have completed a six-month project using data-driven software to improve the operating efficiency of 25 offshore support vessels (OSVs). Now, the software will be installed on all of Bourbon's 104 offshore vessels. Real-time fleet monitoring and enhanced digitalisation of the vessels' reporting systems enabled Opsealog to identify potential improvements in daily operations which resulted in av-

erage monthly savings in CO₂ emissions of 45-50 tonnes per vessel. The software company will now install its systems on board Bourbon's fleet of platform supply vessels and anchor handling tug supply ships. The setup will involve centralised fleet monitoring with real-time vessel tracking and reporting. The data will be integrated into Opsealog's Marinsights platform to identify areas of operation in which fuel consumption and associated emissions can be reduced.



The offshore vessel *Bourbon Explorer 504* is among those ships to be optimised Source: Bourbon

Ulstein delivers CSOV *Olympic Boreas*



Source: Ulstein

The Ulstein SX222 CSOVs have a length of 89.6m and a beam of 19.2m

Olympic Shipping | Norway's family-owned Ulstein Verft has delivered the first of two Ulstein SX222-design commissioning service operation vessels (CSOVs), *Olympic Boreas*, to owner Olympic Shipping. The vessel, designed with a Twin X-Stern, has accommodation for 126 persons in 91 cabins and is intended for effective operation in harsh seas. With four main thrusters – two aft and two in the foreship – the vessel is fast and, with a large gangway system, can undertake walk-to-

work operations effectively, the shipbuilder said. The thruster arrangement makes a significant impact on fuel consumption in dynamic positioning mode. The CSOV's hybrid power setup consists of a substantial battery arrangement and diesel generators that operate at variable speeds, optimising fuel economy. The methanol-ready vessel has space for more batteries, enabling fully electric operation when the necessary infrastructure becomes available.



Rhein-Reise:

Der GEFO Stainless Steel Tanker „Tintoretto“ vor dem Loreley-Felsen

Lore Ley

Die schönste Jungfrau sitzt
dort oben wunderbar,
ihr Geschmeide blitzet,
sie kämmt ihr goldenes Haar.

Den Schiffer in dem kleinen Schiffe
ergreift ein wildes Weh;
er sieht nicht die Felsenriffe,
er schaut nur in die Höh.

Heinrich Heine, 1824

**Die Loreley-Passage war früher eine Gefahrenstelle für die Schifffahrt.
Heute sind die Felsenriffe weggesprengt.**

Ammonia is highly prized as a future maritime fuel. However, there are several hurdles to overcome. Pictured is the design of the ammonia-powered *Yara Eyde*.

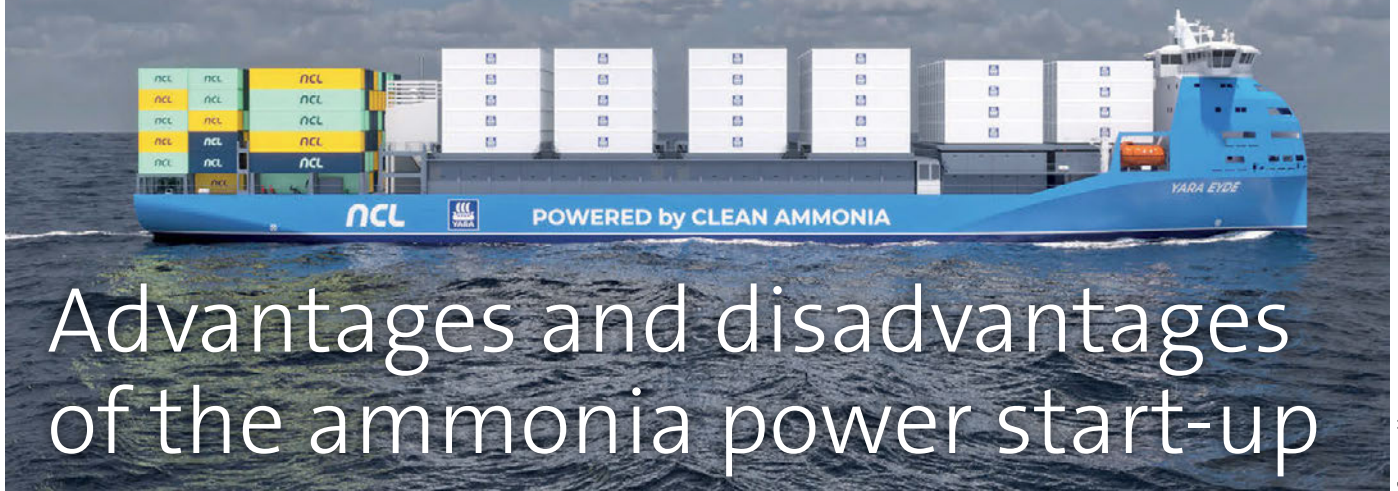

Source: Yara

Advantages and disadvantages of the ammonia power start-up

CRACKING TECHNOLOGY A new take on the transition to an emissions-free maritime sector is being offered by a US start-up which has designed a hydrogen fuel cell system to deliver electrical power, with the fuel derived from cracked ammonia, writes freelance journalist Nick Savvides

New York-based Amogy has developed a scalable modular power system currently housed in 20ft containers, each with capacity to produce 200kW. Four boxes generating 800kW of power is sufficient for a 300-TEU vessel ordered by the regional operator North Sea Container Lines (NCL).

Scalability is critical, with some 86% of maritime emissions coming from large deepsea vessels including bulkers, tankers and fast container ships. To reduce emissions from these vessels to zero by 2050 is considered the shipping industry's biggest challenge.

Ammonia is seen as a key fuel to achieve that goal, normally as a fuel in an internal combustion engine. But Amogy's CEO Seonghoon Woo told Ship&Offshore: "We would like to differentiate our ammonia cracking technology from traditional ammonia combustion engines. Unlike these engines, which emit significant quantities of NO_x and N₂O, our ammonia-cracking process primarily produces nitrogen (N₂) and water as emissions. Any trace amounts of other harmful emissions remain significantly lower than industry standards."

It is the lure of clean energy that has persuaded a number of major industry players to invest in Amogy including Norwegian chemicals company Yara, which produces fertilisers and therefore handles ammonia. The company has commissioned the

first electric-powered container ship, *Yara Birkeland*, that will eventually become an autonomous vessel.

Amazon, which is thought to have invested USD 220 million in the start-up in the hope that it can decarbonise its maritime supply chain, is another backer of this new technology. NCL has also shown its faith in the technology and has ordered the 300-TEU ship, which is scheduled to be delivered in 2026.

Amogy's technological breakthrough has been to develop a system to crack ammonia on board ship. This enables production of the hydrogen necessary to develop the electrical power that will supply energy to the ship's propulsion as well as its auxiliary systems.

Woo said that the key ingredient in the system is the catalyst, which is a rare metal known as ruthenium, which the Royal Society of Chemistry says is found in South Africa, Russia and Zimbabwe. The ruthenium would need to be replaced around every five years, he said, adding that the companies, NCL and Amogy, will "start small but the technology can be scaled up to much larger, deepsea, ships."

Scaling up is not just for the maritime sector, but can be applied to other sectors that find decarbonising a challenge. Amogy's website declares: "Founded in 2020 by four MIT PhD alumni, we aim to enable the decarbonisation of the hard-to-

abate sectors, including shipping, power generation, and heavy-duty transportation, with our ammonia-based, emission-free, high energy-density power solution."

The company is already retrofitting a 1-MW tug, *NH3 Kraken*, as its first ammonia fuel cell-powered vessel. It is also renovating a production facility in Houston, Texas, that will roll out its technology on a commercial scale.

Meanwhile, NCL's 300-TEU vessel will be the first container ship operating with the ground-breaking ammonia-cracking technology. However, the company is coy about discussing the development.

Bente Hetland, CEO of NCL, is quoted in an Amogy press briefing: "The Amogy ammonia-powered system meets the criteria for our latest project for very small container feeders," she said. "This unique partnership with Amogy will allow us to demonstrate it is possible to provide world-class service and cut emissions at the same time," she noted.

Having claimed to have cracked the maritime greenhouse gas (GHG) conundrum, you would expect both Amogy and NCL to be shouting from the rafters telling anyone who will listen of the innovation. Hetland, however, refused to respond to further questions on the vessel's development, instead offering a succinct, "Nothing to comment yet on the other [Amogy] project." Preferring instead to discuss

another ammonia powered newbuilding, the *Yara Eyde*, which will be fitted with a WinGD X52 DF-Ammonia internal combustion engine. Nevertheless, the key element to the success of the NCL container ship will be its ammonia cracking technology, which is as yet untested in a marine environment.

Woo, however, gives some insights into how the features of the system: “Ammonia cracking splits ammonia into its base elements of hydrogen and nitrogen. The hydrogen is used to create electricity in the fuel cell, meanwhile the nitrogen is safely released into the atmosphere, which is already made up of about 78% nitrogen,” he replied when asked about the nitrogen waste product.

That the nitrogen can be “safely released into the atmosphere”, however, is not a view that is necessarily shared by the UN Environment Programme (UNEP). According to UNEP’s 2018-2019 Frontiers Report, “nitrogen costs the global economy between USD 340 billion and USD 3.4 trillion annually when taking into account its impact on human health and ecosystems.”

UNEP warns of the dangers caused by nitrogen, mainly from the agricultural use of fertilisers, but also from gas emissions, alerting the public to the fact that the gas is 300 times more potent as a GHG than carbon dioxide, while remaining active in the atmosphere for more than 100 years. “Altogether, humans are producing a cocktail of reactive nitrogen that threatens health,

climate and ecosystems, making nitrogen one of the most important pollution issues facing humanity,” said UNEP.

Amogy countered: “First, to ensure clarity on the terminology: nitrogen (N_2) is different from nitrous oxide (N_2O),” explained Woo. The reference in the Frontiers Report “Is not nitrogen in its pure N_2 form, but nitrous oxide (N_2O), which is a greenhouse gas and is about 300 times more powerful than CO_2 ,” he said.

He continued by saying: “Nitrogen (N_2) in its original form is the most abundant gas on earth at about 78% of the air that humans breathe. The ammonia (NH_3) that is fed into Amogy’s ammonia-cracking technology is produced from that abundant N_2 . Therefore, the N_2 that Amogy releases from the system is not excess N_2 and is completely harmless to the environment.”

The nitrogen cycle is a well-known phenomenon and is required by living organisms to convert nitrogen into usable substances by synthesising proteins, nucleic acids and other compounds containing nitrogen. The process, known as fixing, combines nitrogen with hydrogen to form ammonia, according to the UK’s Microbiological Society.

Nitrogen is crucial to the air we breathe and for the growth of plants which we eat, but there must be a balance, too much or too little nitrogen can be catastrophic, causing algae blooms which suck the oxygen from water, or causing plants to die through a lack of nutrition.

“The nitrogen cycle is a series of processes that converts nitrogen gas to organic substances and back to nitrogen in nature. It is a continuous cycle that is maintained by the decomposers and nitrogen bacteria,” said the society.

Professor Mark Sutton of Edinburgh University, a specialist in ammonia and the wider nitrogen cycle, was not convinced by Amogy’s claims. According to him, nitrogen in the atmosphere can react with lightning to make nitric acid and this can form N_2O , which is an ozone depleting chemical and is not covered by the Montreal Protocol on ozone depleting chemicals, signed in 1987. “Five to 10% of nitrates can be formed in this way, it is not critical, but it is not insignificant either,” he said.

Moreover, Sutton said he would like to see a peer-reviewed study that would demonstrate how ammonia cracking could avoid harmful GHG emissions, and also show there are no other effects that “we haven’t thought about”. In addition, the cracking process is thought to have an “energy penalty” which could see the process “lose 40% of the ammonia’s energy in the cracking process,” although Sutton said he had not seen the details of this, and could not be unequivocal about this process.

However, there would need to be further investigations to understand the process, because if ammonia cracking loses energy, there will be a “big issue with the efficiency question”.



**LEHMANN
MARINE**



Meet us at booth A4.105



SAFE AND COMPACT ENERGY STORAGE SOLUTIONS

- Superior energy density
- Compact & lightweight
- Flexible & easy installation
- Innovative air-cooling
- Inherently safe LFP chemistry
- Cobalt- & nickel-free
- Scalable & modular design



LEHMANN-MARINE.COM

Methane abatement gathers momentum as initiative grows

MAMII As LNG continues to be a popular option for dual-fuel newbuildings and record LNG carrier contracting continues, tackling methane slip is a top priority. The Methane Abatement in Maritime Innovation Initiative (MAMII) was set up in September 2022 to tackle the issue. Led by Lloyd's Register's Safety Accelerator, MAMII's membership is a 'who's who' of LNG shipping and reflects the level of concern over methane and its abatement.

Experts warn that unless the LNG global supply chain and all of the enterprises involved at every stage succeed in cracking the methane issue, the cleanest hydrocarbon will become obsolete far sooner than it should. The result would be the creation of huge challenges for many countries and their future energy security. It is a truly global issue.

The methane challenge is not confined to naturally occurring gas; recently developed variants of the fuel, including e-LNG, synthetic LNG and bio-LNG, face exactly the same problem. And so do the various blends of LNG that are being developed to reduce carbon emissions.

Panagiotis Mitrou is Lloyd's Register's Global Gas Segment Director. He explains that over a 100-year timeframe, methane has a global warming potential 28 times greater than carbon dioxide; over a 20-year period, this rises to 87.

There is, as yet, no regulatory framework on methane emissions. But the clock is ticking and it is only a matter of time. Regulations are thought to be imminent in Europe through its Emissions Trading System and

FuelEU Maritime, and the IMO is expected to integrate methane into the framework of its future climate-related measures.

The MAMII project, led by Lloyd's Register's Safety Accelerator, was established two years ago as a vehicle to tackle what is widely seen as the biggest obstacle facing LNG as a transition fuel. Its membership, a growing list of blue-chip companies, continues to expand, with the UK P&I Club and TotalEnergies the latest new signatories.

Steve Price, MAMII Programme Director, is delighted with progress. Much has been accomplished so far, including production of a Methane Emission Reduction strategy report for partners, covering methane regulatory requirements, well-to-tank and tank-to-wake analysis, and cost benefit assessments.

He explains that the partners are using science and engineering to understand the methane emission problem. They have created a tech ecosystem in which industry partners collaborate to adapt the new technologies for the marine market.

"We have discovered that technology has the ability to mitigate methane emis-

sions on board a ship," Price declares, "and we have developed a protocol to guide regulators in the setting of methane measurement standards."

He explains that measurement of well-to-tank emissions can be improved by the adoption of a transparent certification system. This would enable LNG fuel users to make the best choice of LNG provider.

But the fact remains that neither ships nor their engines are yet designed to incorporate the new technologies that are being developed. With rapid LNG fleet expansion and more ships adopting LNG as a dual-fuel option, methane emissions are rising.

The problem, Mitrou points out, is becoming more pressing and extends far beyond the shipping sector. Geopolitical events have radically changed the global backdrop. Energy security is a top priority for many countries and access to LNG is an essential part of their future energy strategies. No surprise, he says, that seaborne trade in LNG is increasing, LNG carrier orders are still at record levels, and sea miles are rising fast.

Mitrou points out that methane emissions occur at various points along the supply chain – from production to delivery. However, he says that methane slip that occurs as a result of an incomplete combustion process in ships' engines is the biggest source of leakage and the most pressing challenge.

"We can seal the entire cargo and fuel supply system," Mitrou explains, "but what happens within the engine is not easy to control. So we need to monitor, adopt technologies that improve the combustion process and, eventually, to adopt methane abatement measures at the exhaust."

He explains that ships' engines vary in their methane performance. Engine developers have made great strides in cutting methane slip in high-pressure Diesel-cycle



Among the initiative's members is cruise giant Carnival Corporation

Source: Lloyd's Register

> MAMII MEMBERS

Capital Gas	Mediterranean Shipping Company
Carnival Corporation & Plc	Mitsui O.S.K. Lines
Celsius Tankers	MISC
Chevron	NYK Line
CoolCo	Seaspan Corporation
Global Meridian Holdings	Seaspeak
JP Morgan	Shell
Knutsen Group	TMS Cardiff Gas
Lloyd's Register	TotalEnergies
Maran Gas Maritime	United Overseas Management

engines to relatively low levels. However, low-pressure Otto-cycle engines are poor performers and, unfortunately, these cheaper engines are the ones that many shipowners and operators have chosen.

But it is not an issue that can be ignored. Mitrou points out that ships' carbon intensity indicator (CII), an IMO-generated formula for determining the carbon efficiency of ships, is supposed to improve by 5% a year over the second half of this decade.

However, as things stand today, methane is not included in the CII calculation. When it is, many LNG carriers and ships that burn LNG as fuel will plunge into the categories where their owners need to take urgent steps to improve their performance. Even the best engines – the high-pressure Diesels – will be affected. Mitrou estimates that in a best-case scenario and a timeframe of 100 years, including methane in the CII formula is likely to reduce a ship's carbon efficiency by 8-10%. In the worst performing engines, and a more probable timeframe of 20 years, this figure is likely to rise by a frightening multiple, driving many ships out of compliance. This would apply not only to a large number of LNG carriers, but also to cruise ships, ferries, and other dual-fuelled vessels, Mitrou warns.

MAMII's various member companies are focusing on finding a catalyst that can be used either to improve the combustion process, thereby reducing methane slip, or converting unburnt methane into something less harmful that can be managed. So project partners are assessing engine technology as well as abatement at the exhaust.

Developing an effective catalyst, however, is extremely complex because methane – CH_4 – is very stable and therefore difficult to transform into something else. Mitrou believes that high exhaust gas temperatures may eventually be essential to de-

veloping an effective catalyst. The temperature issue, he says, is why it has not proved possible to develop a catalyst so far.

But, he says, catalysts are likely soon to become available and will work with some engines, particularly those with the highest slip rates today. However, the catalysts will come at an enormous cost for the entire LNG supply chain.

"But other likely fuels, such as methanol, ammonia, and hydrogen do not carry the same problem," Mitrou points out. "We have to sort it out. Every molecule of methane that slips, counts. And it will become a strategic risk for companies that fail to address it: they will get bad press and suffer reputational damage."

Price acknowledges that the issue is urgent. He stresses that MAMII is not an advocate for LNG. But its aim is to prevent it being ruled out as a source of power in the future. He points out that MAMII members have shown great resolve so far, having embarked upon a range of pilot projects and initiatives that are in progress today.

Much has been learnt from other sectors. Methane measurement comes from smart cities. And partners focusing on methane abatement might well establish a dialogue with the operators of power stations. For those looking at catalysts, a dialogue with certain car manufacturers could prove useful.

Many of MAMII's 20 partners, who each pay USD 68,000 to join, are engaged in projects that, for the moment, remain confidential. But Price says that the programme is creating fresh insights through the range of measurement and abatement pilot projects in progress. Partners are keen to prove new abatement technologies at scale and generate best operational practice for methane reduction, he concludes.

This article is an updated version of a piece that was commissioned by Lloyd's Register



WE BUILD

PM high torque motors
PM synchronous motors
AC induction motors
Torque range up to 800 kNm
Power range up to 4 MW

USED FOR

Direct drive main propulsion
PTI/PTO applications
Shaft generators
AHC winches
Hydro power plants
Flywheel energy storage



www.oswald.de

Benzstraße 12 | D-63897 Miltenberg
oswald@oswald.de | +49 9371 9719 0



Accelerating the shipping energy transition

FUEL FLEXIBILITY Cost parity between sustainable shipping fuels and fossil fuels can be reached within the next few decades as a result of evermore stringent international regulations. Mikael Wideskog, Director, Sustainable Fuels & Decarbonisation at Wärtsilä, describes how to support this most effectively. The shipping industry needs to look towards focusing on a number of strategies, he says, such as investing in fuel flexible technology, addressing the cost of transition, and fostering a system of intra and inter-sector collaboration.

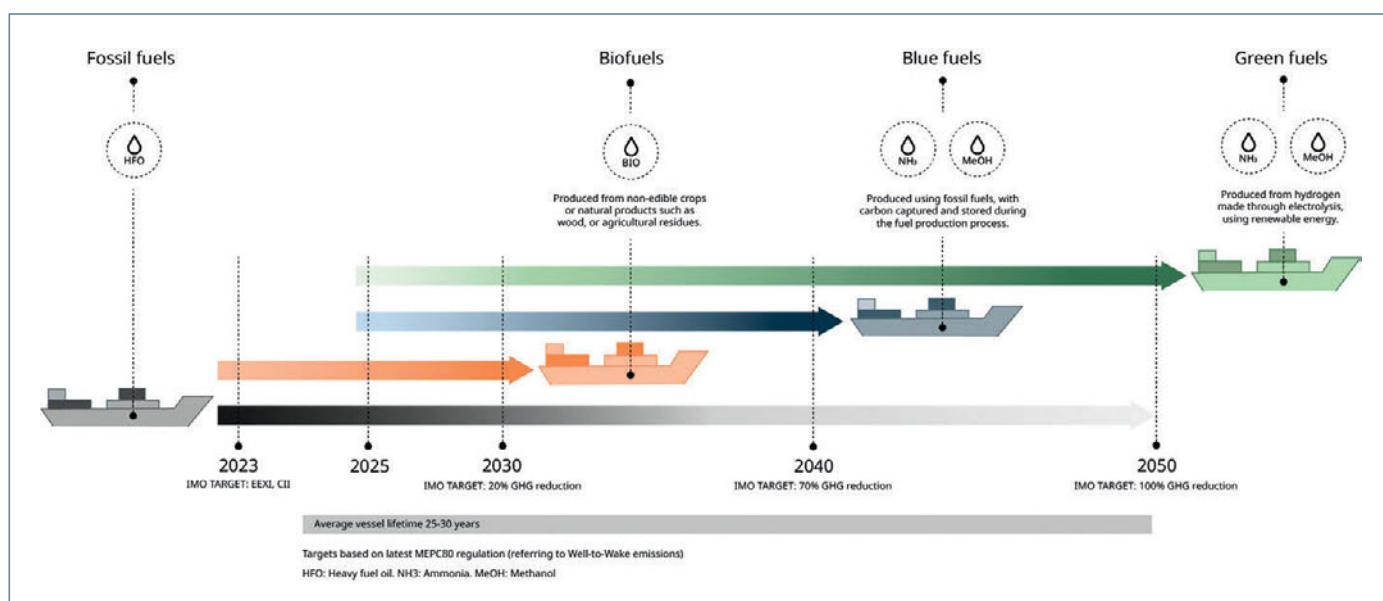

Sustainable fuels roadmap to 2050

Source: Wärtsilä

The essence of a recent industry analysis shows that cost parity could be reached between sustainable shipping fuels and fossil fuels by 2035 as decisive emissions policies and regulatory pressures ramp up. According to recent research from a report Wärtsilä has published on sustainable shipping fuels, regulations like the EU Emissions Trading System (EU ETS) and FuelEU Maritime could cause a near-doubling of the cost of using fossil fuels by 2030.

Furthermore, despite sustainable fuels forecasted to remain three to five times more expensive than today's fossil fuels, the gap between sustainable and fossil fuels could close with the introduction of further regulations. Current regulations are already providing financial pressure to reduce emissions.

The EU ETS enables operators using zero-carbon or near-zero fuels to pay less

than others using more carbon-intensive fuels. And, from January 2025, FuelEU will require vessels to implement stepped reductions in the greenhouse gas intensity of fuels used between now and mid-century.

While this looks promising for reaching 2050 decarbonisation targets, the question of identifying some practical methods of reducing costs and accelerating the shift towards sustainable fuels remains essential to the shipping industry's responsibilities. To support the fuel transition to the greatest degree possible, there are several options available to stakeholders.

The pathway to decarbonisation

Along with projecting a cost parity, Wärtsilä's "Sustainable fuels for shipping by 2050 – the 3 key elements of success" report highlights the wide range of pathways that have opened up as the sector rapidly seeks to achieve a lowering of greenhouse

gas emissions. Industry analysis, such as this report, is helping to provide further clarity around these options.

"Individual operators can transform uncertainty and risk into competitive advantage and lower operational costs by investing in efficiency and fuel flexibility," the report states.

There is an understandable focus from operators on energy efficiency and fuel flexibility improvements for their vessels. These are required both to meet emissions mandates such as IMO's Energy Efficiency Index for Existing Ships (EEXI) and the Carbon Intensity Indicator (CII) as well as easing the application of alternative fuels in the future.

Investing in fuel flexibility, in particular, lays the foundations for operators to meet increasingly stringent emissions targets while allowing manoeuvrability when it comes to accessing different fuels in the

face of ongoing disruptions in the energy sector. Managing costs requires early investments in new on-board technology for new forms of energy and working in tandem with new regulations makes this all the more lucrative in the long-term.

Commercial availability

Energy efficiency and fuel flexibility are both central to forming total resilience as more fuel options come to market. These considerations are all the more essential as the technology capable of setting the stage for widespread fuel flexibility is rapidly becoming viable commercially.

In 2023, the Wärtsilä 25 dual-fuel LNG engine range became the first commercially available engine of its kind capable of using ammonia. Two years ago, the Wärtsilä 32 Methanol, Wärtsilä's first newbuild methanol engine, and the MethanolPac fuel supply system were announced along with four other engines being added to the line-up. On the ammonia front, it was announced in February this year that two medium gas carrier newbuildings for Belgian firm Exmar LPG would use Wärtsilä's new ammonia fuel supply system (AFSS).

On the ammonia front, it was announced in February this year that two medium gas carrier newbuildings for Belgian firm Exmar LPG would use Wärtsilä's new ammonia fuel supply system (AFSS). Alongside expanding alternative fuel offerings across Wärtsilä's engine portfolio, developing the required fuel supply and storage systems exemplifies how technological capabilities in fuel flexibility are being suc-

cessfully implemented by vessel owners across the industry.

A costly transition

While business optimism and new technologies being made available on the market are important, the industry is still waiting for the widespread availability of zero and near-zero carbon fuels that can effectively supplant fossil fuels. Despite long-term aims to reduce fossil fuel use in shipping, there is no immediate alternative that is widely commercially available. Therefore, incremental improvements are key.

Despite methanol newbuilds surpassing LNG as the preferred alternative fuel choice in 2023, LNG is continuing to play an important transitional role as a less polluting energy option for vessels. Based on Wärtsilä's report, biofuels will serve a similar purpose in the 2030s before blue fuels, with carbon capture technology acting as a bridging fuel towards green, synthetic fuels, which will become prominent in the late 2030s and early 2040s.

However, this process will require significant investment. According to the 2023 UN Review of Maritime Transport, to sufficiently increase production, fuel distribution and bunkering infrastructure, an investment of up to USD 5 trillion in near-zero fuels and propulsion technologies by 2050, as well as an annual USD 8 billion to USD 28 billion annual liquidity injection, will be required.

The purpose of this investment is to fully decarbonise by 2050, requiring the industry to replace around 270 million

tonnes of heavy fuel oil with alternative fuels on an annual basis.

Despite a lack of availability, demand is increasing, as evidenced by the existing order book for vessels adopting new fuels. Proactive operators are recognising the need to ensure onboard infrastructure is ready as cleaner fuels become more viable and costs of traditional fuels rise. To ensure that alternative fuel supply availability meets growing demand, supporting clean fuel production projects or directly investing in supply are other ways in which large ship operators can maximise their flexibility.

Collaboration is essential

Actions within a company's own trajectory can only go so far, which is why industry collaboration is central to making these aims a reality. As synergy between ship operators can be more effective than isolated efforts, so will cooperation between governments, regional authorities and industry regulators. This kind of cross-sector interactivity will be crucial.

Based on the analysis found in the sustainable fuels report, pooling purchasing power will reduce overall fuel prices and minimise supply chain costs for individual companies. Intra-industry collaboration also allows smaller companies, which make up a significant portion of the fleet, to access knowledge they may not otherwise have.

For example, Wärtsilä has been supporting operators through feasibility studies and execution planning, along with new product implementation.

Visit us at WindEnergy 2024 in Hamburg from 24-27 September at **stand 135 in hall B6**

Strong and safe. In the event of a short circuit.

Maximum safety: Prevents cables from coming loose in the event of a short circuit.

Reliable fastening: Tightly and permanently secures cable bundles.

Compliant: Conforms to standard IEC 61914:2021.

www.panduit.com



PANDUITTM
infrastructure for a connected world

Rebranded OceanWings expands sail portfolio

VERTICAL WINGSAILS | Paris-based OceanWings, previously Ayro, is expanding its product portfolio and targeting sectors including tankers, bulkers, car carriers and cruise ships of all sizes. Its wind-assisted propulsion system (WAPS) technology centres on semi-rigid and new rigid OceanWings® of ‘two flap variable camber’ design

which, the company claims, has demonstrated fuel savings over most operational scenarios and environmental conditions. The company’s sails now have a ‘safety-by-design’ feature. This automatically protects both the sails themselves and the ship when wind or sea conditions exceed certain thresholds.

There is now also a tilt mechanism to address air draft restrictions, and an elevator mechanism specially designed for container ships to comply with their port operation constraints while also minimising the impact on container capacity. The company claims that its design is the only one that provides a design that can be lowered or reefed, a critical feature for vessels where tilting is not an option.

The sails are made from the same composite materials and manufacturing processes as wind turbine blades. This provides benefits including resilience, lifespan, manufacturing options, pricing, and scalability. The new modular design also optimises transport and installation.

OceanWings’ CEO, Emmanuel Schalit, declared: “The entire OceanWings product range is based on the same aerodynamic design that is now proven to deliver class-leading payback to shipowners, while adding more flexibility and integration options for newbuilds and retrofit ... We have also focused on improving our design and processes to be able to deliver faster and with consistent quality to our customers around the world.”

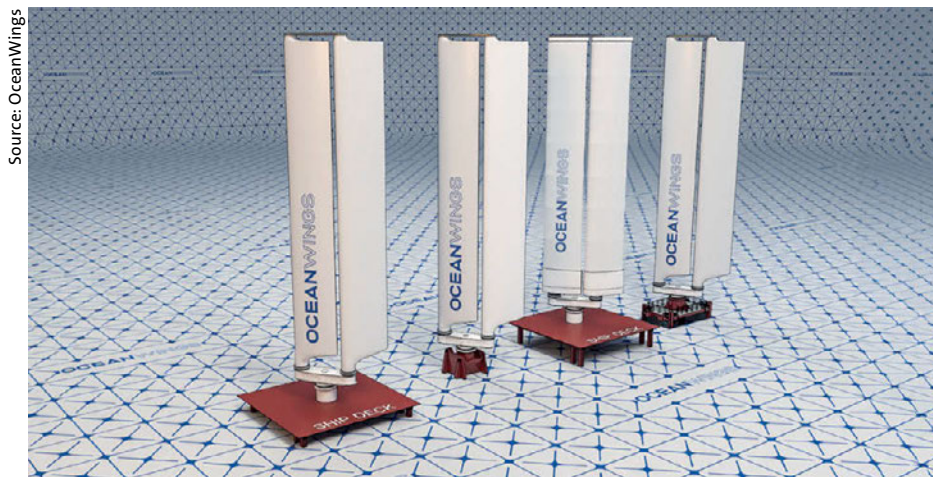

The wind-assisted propulsion system technology centres on OceanWings® technology

Ammonia research project on performance and safety

COLLABORATION | Korean Register (KR) is to collaborate with partners Hanwha Ocean, Amogy, and Hanwha Aerospace in the development, certification, and application of ammonia reformers and ammonia fuel cell systems in shipping. The classification society will oversee technical cooperation between the parties, which specialise in shipbuilding, the decarbonisation of hard-to-abate industrial sectors, and aerospace, respectively. Ammonia reformers are used to produce gas with hydrogen as the main component. This is then supplied to fuel cell stacks, which will provide the energy required for auxiliaries and hotel requirements aboard ships, and possibly also power for small vessels in the future.

The aim of the project is for KR to be in a position to issue a New Technical Qualification (NTQ) certificate, verifying the clas-

sification society’s requirements on performance and safety. The fuel cell systems will also be assessed for compliance with international conventions and standards.

KR’s senior vice president, Yeon Kyujin, commented: “This agreement will be an important milestone in applying ammonia technology to ships. KR will continue to drive the decarbonisation of the maritime industry by providing technical support to ensure that reformers and fuel cell systems can be safely applied to ships.”

Amogy CEO and founder, Woo Seonghoon, stated: “This agreement brings us one step closer to the commercialisation of eco-friendly ships using Amogy’s ammonia-based fuel cell systems. I believe multi-party collaboration is vital for the decarbonisation of the shipping industry, and we will continue to do our best to ensure the safe introduc-

tion of ammonia and ammonia-based fuel cell systems into the ship market.”

Kim Hyungseog, Hanwha Ocean EVP and CTO, said: “This agreement will strengthen Hanwha Ocean’s competitiveness in the eco-friendly ship market. We will continue to take a leading role in developing crucial new technologies for carbon neutrality in the shipping industry.”

The head of E-P propulsion System Business Group at Hanwha Aerospace, Moon Seunghak, added: “The introduction of ammonia-based fuel cell systems is essential for the decarbonisation of the shipping industry. We expect to maximise synergy through the cooperation of the four companies. This technological development will play a key role in establishing a carbon-neutral ecosystem in the ship transportation market.”



**SUPER LOUD, MEGA DUSTY, ULTRA HOT.
WHAT CAN STAY COOL WITH ALL THIS?
THE 6X[®]. FROM VEGA.**

Dust, noise, temperature fluctuations – VEGA developed the VEGAPULS 6X radar level sensor for precisely such conditions. Ideal for all bulk solids and all plant operators who want to maximise the productivity of their processes.

VEGA. HOME OF VALUES.

www.vega.com/radar

SMM 2024: Hall B6, stand 101

VEGA

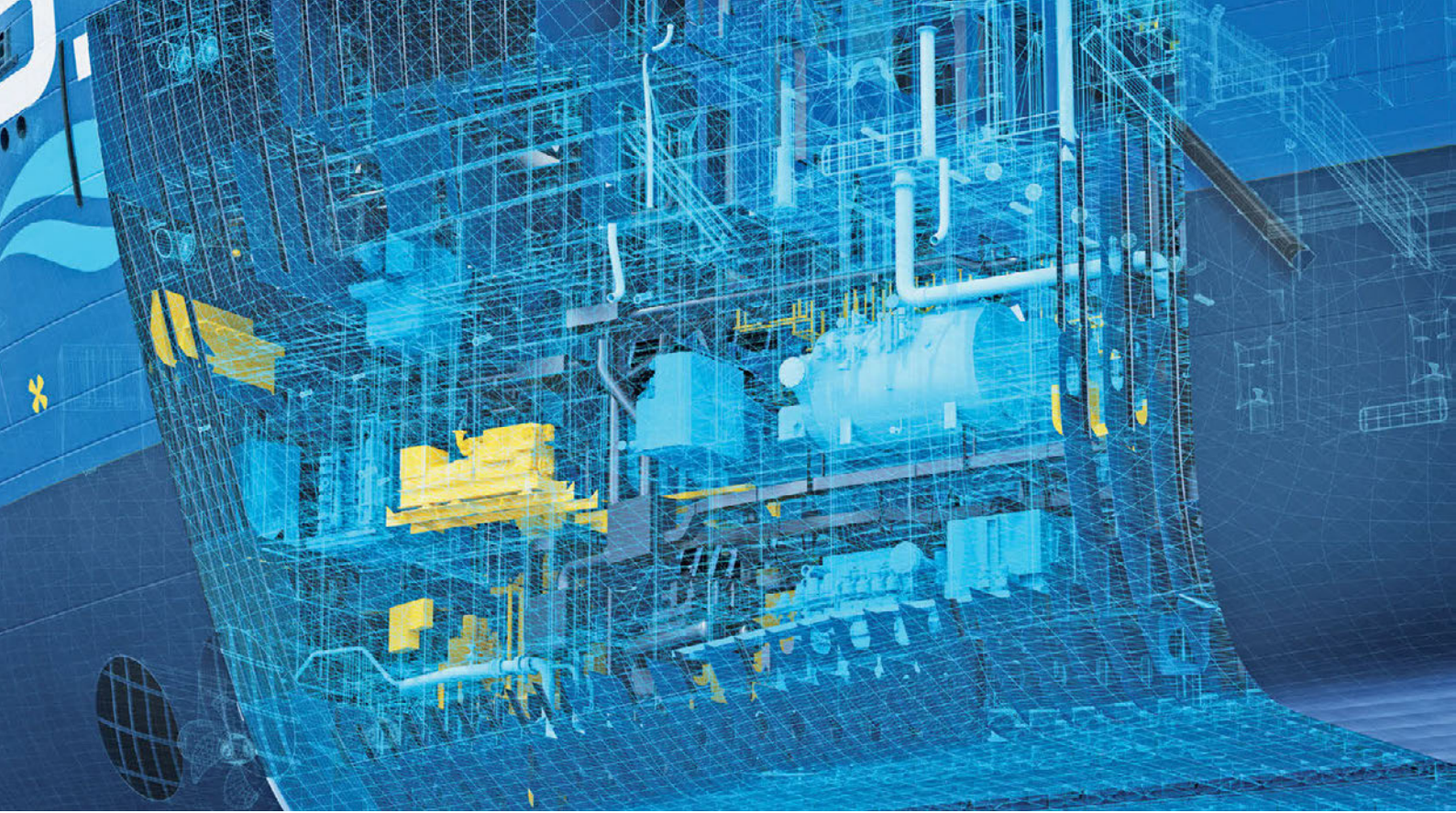

Digital view of the side ship deconstructed

Source for both images: SSI

Automation ready for a great leap forward

3D SHIP MODELS Manual intervention is still relied upon to drive machinery on the production floor, but intelligent 3D ship models can automate the process, writes Scott Raeside, product business analyst at SSI, a service and software provider to the maritime industry

The ability to free up highly skilled workers to focus on complex production tasks rather than tedious and menial ones is a major win for any shipyard.

However, only a few shipyards have been able to embrace this innovation. Part of the reason lies within the detailing and control of the production information generated to

control shop-floor machines, which can be time-consuming and prone to errors.

Automated robotic cutting, bending and welding of steel components in ship construction has been possible for years. Likewise, reducing the amount of time designers must spend interacting with mainly two-dimensional production documentation, or manipulating file formats, allows both for better accuracy and more efficiency in creating and revising the model and in automating the manufacturing process.

Bridging these two realities

The level of complexity in every phase of construction and the workflow of a shipyard will always vary, but the desire to incorporate automation where possible remains constant. For decades there has been a dependence on manually created outputs, which in turn drive manual tasks for the production team. This can mean updating a series of drawings based on time-consuming workflows to get the output data back

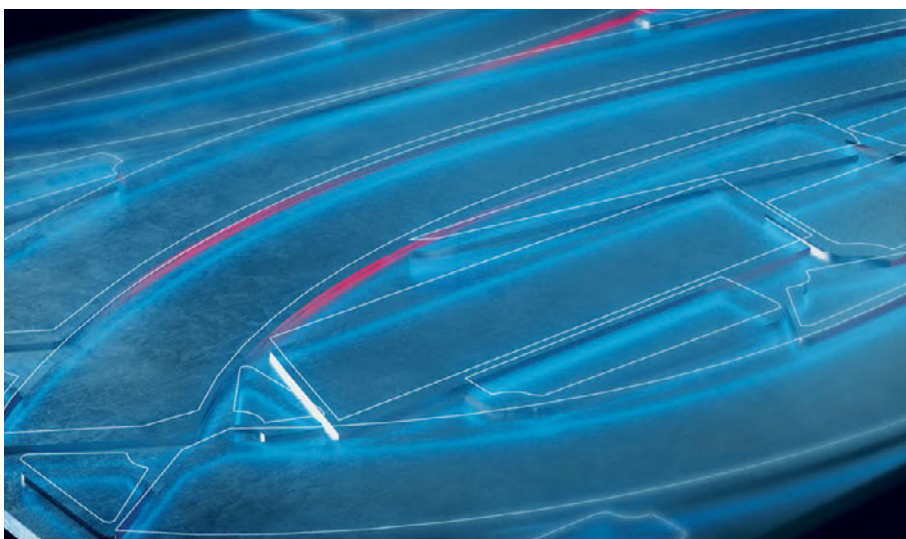

Automation will mean less physical interaction with the model and make access more efficient

on to the shop floor or manually measuring and marking up plate from a 2D drawing. For example, opening thousands of spool and assembly drawings, annotating and validating them is slow and tedious. Such tasks represent a large time commitment for designers and as a result, a more expensive ship design process.

Often the answer proposed to some of these manual workflow issues is to incorporate third-party software – in addition to the core 3D package used for ship design – which in turn may create bigger changes to shipyard workflows to ensure compatibility. On projects where schedules are aggressive and budgets are tight, this degree of upheaval is a non-starter.

Removing the need to introduce third-party software or reducing the amount of user interactions needed to create an output by driving this information directly from the 3D digital model software is an exciting step in the right direction. It would be unrealistic to suggest that it is possible to create such outputs with no physical intervention at all, but we think that a strategy of ‘80% no touch’ is achievable and in sight.

The philosophy behind the ‘80% no touch’ approach is simple: we enable creation of the deliverables that are required to build the ship accurately. This includes traditional production documentation as well as an increasing capacity to drive machines on the shop floor based on data from the Marine Information Model (MIM).

The complexities of shipbuilding, non-repeating production tasks and the fact that humans are still better suited to complex cutting/welding/bending means we are still working towards complete and transparent automation. But SSI does have the knowledge and information required to reduce some of the pain points.

By using an accurate rich 3D product model, it is possible to create more efficient production outputs and communicate directly with the machinery in place in most shipyards. Automation will not eliminate the requirement for the user to interact physically with some of the outputs from the model, but the aim is to make it faster for them to access, modify or verify information accurately and efficiently.

The ability to drive production machinery directly from information stored in the MIM creates the potential for tremendous efficiency and accuracy improvements. This approach can reduce, or in some cases eliminate, the risk of human errors.

Taking a shipbuilding project from concept to completion is a long and complex process. Task-specific software support of the people and tools is the path innovative shipbuilders are taking to simplify this complex process. Shipyards will always rely on the skills and expertise of people in construction but if we can make the process easier, then the result will be more efficient and of higher quality.

Decades of experience in the industry lead us to recognise that change is a reality and that systems must adapt to the changing needs of shipyards. A strategy of enabling operators to drive machinery with as little manual intervention as possible seeks to create efficiencies and keep shipbuilders up-to-date with the latest technology and approaches that are available to support their projects.

the power to control

The Future in View. Always on Course.

Our Competence. Our Responsibility.

Autonomous Shipping
Everything under control for the optimal route

Smart Maintenance
Efficient maintenance and monitoring availability

Eco-Friendly
Redundant, safe and environmentally friendly

OpenBridge, MTP
Standards for more security and smooth installation

Join us:
SMM, Hamburg, Germany
September 03-06, 2024
Booth: B6.307

Our new
M100 I/O System

Our proven
M200 Controller System

www.bachmann.info

DNV launches new in-operation class notations

UPDATE | DNV has published updates to its rules for classification of ships and offshore structures. In addition to rules supporting the development and deployment of decarbonisation technologies, the new in-operation class notations seek to bring clarity to the responsibilities of class customers for notations that have a mix of design and operational requirements, the classification society said.

The new notation clearly shows the split of responsibilities between shipyards engaged in construction, and owners and operators who subsequently manage assets in service, it added.

As part of the new rules, DNV is introducing two new class notations, gas fuelled

hydrogen and onboard carbon capture and storage (OCCS).

Although hydrogen is a potential zero-carbon fuel for shipping, it is not yet covered by international regulations. The gas fuelled hydrogen notation sets out requirements for fuel systems, fuel bunkering connections, and energy consumers.

The first OCCS systems have already been installed and provide a new technology for reducing emissions. The OCCS notation offers a framework for these new systems' requirements including exhaust pre-treatment, absorption, after-treatment systems, liquefaction, CO₂ storage, and transfer ashore.

The new rules include new boil-off gas notation, live-fish notation, pontoon stability

in heavy-lift operations, new electric vehicle notation for additional safety systems on board vehicle carriers, and revised rules and standards for diving systems aligned with the IMO's 2023 Diving Code.

DNV Maritime's global technical director, Geir Dugstad, commented: "One of the most striking aspects of the maritime industry today is the huge diversity of challenges and opportunities where our customers are looking for classification support. It's not just new fuels, but ways for owners and managers to demonstrate their own efficiencies, new vessel types to unlock new markets, through to advanced technologies like onboard carbon capture."

The new rules will enter force on January 1st, 2025.



SHAPING A SUSTAINABLE FUTURE

WAGO offers solutions for your sustainable future projects. Proven in hybrid concepts and for controlling and monitoring fuel cells, we are your experienced partner. With our reliable and certified solutions, as well as maritime features such as redundancy, we'll help you to shape a sustainable future.



www.wago.com/marine

Combined engine gets EU certification



The Damen D16 engine can be used on a variety of vessel types across the maritime industry including tugs, workboats, high speed craft and inland barges and is available for newbuilds and retrofits

Source: Damen

STAGE V | Damen Shipyards has announced that its recently introduced engine combined with a Damen marine emission reduction system has been awarded EU Stage V certification. The Damen D16 marine engine and aftertreatment system, designed internally by Damen Sustainable Solutions, has been developed to reduce emissions and increase power efficiency. The engine is suitable for a range of vessels including tugs, workboats, high-speed craft, and barges, and is available for new vessels and retrofits.

The engine is based on the Volvo Penta D16 IMO II. It is fuel-efficient, has SO_x, NO_x, CO₂ reduction systems, and can operate on hydrogenated vegetable oil (HVO), providing further emission reductions.

The EU Stage V engine certification process was completed together with Volvo Penta dealer Haisma in Harlingen, Netherlands. In a statement, Damen said that it can now offer clients a proven emission reduction system that meets the requirements of the EU Stage V, ultra-low emission vessel (ULEV) and IMO Tier III regulations and is certified with HVO100, EN590, ISO8217 – DMA fuel.

Damen sales & operations manager, Sustainable Solutions, commented: “Rigorous and extensive testing of the engine in cooperation with the Damen marine emission reduction system was carried out by the team. The EU Stage V certification award was a welcome reward and one we are very proud of at Damen. It allows us to offer our customers greater efficiency and flexibility, whatever the future brings, on every water of the world.”

Partnership accelerates landing craft development

CAIMEN® LARGE | DNV and BMT Partners have signed a Memorandum of Understanding to accelerate the development of an Australian version of a Landing Craft – Heavy (LC-H) version of BMT’s Caimen® Large landing craft for the Australian Army. The collaboration will ensure that the asset’s design is tailored to the Army’s requirements, technical risks are identified and managed, and potential delays are avoided by having early classification society engagement.

The partners aim to enhance the ‘design maturing’ of the Australian variant of the Caimen Large craft, ensuring that BMT can supply the asset with effective multi-mission amphibious capabilities to the Australian Defence Force. The Caimen Large is designed to carry out amphibious assaults and humanitarian missions.

Graeme Naylor, BMT’s regional managing director APAC, commented: “Partnering with DNV enables us to leverage their unparalleled expertise in certification and technical advisory, ensuring our designs meet rigorous standards and contribute effectively to Australia’s defence strategy. This MoU sets the stage for a dynamic collaboration that will ultimately deliver enhanced operational capabilities to the Australian Army through a risk-based ship design.”



HEICO FASTENING SYSTEMS

The best value to secure and tighten bolted joints



MV »Sindre Knutsen«

**General**

Builders	Daewoo Shipbuilding & Marine Engineering Co., Okpo/South Korea
Yard no	5483
IMO no	9905928
Call sign	LAOM8
Flag	Norway (NIS)
Port of registry	
Vessel type	Crude oil tanker
Delivery	August 30, 2022
Owner	Knot Shuttle Tankers, Haugesund/Norway
Managing owner	Knutsen NYK Offshore Tankers, Haugesund/Norway
	(Joint venture between NYK and TS Shipping Invest (TSSI) of parent company Knutsen)

Classification DNV ✱1A Tanker for oil BIS Bow loading Battery(Safety) BWM(T) CCO Clean(Design) COAT-PSPC(B, C) COMF(C-3, V-3) CSA(FLS2) CSR DYNPOS(AUTR) E0 ESP F(A, M, C) Gas fuelled LNG HELDK(S, H) LCS NAUT(AW) Plus Recyclable RP(1, 50) SPM TMON(oil lubricated) VCS(2)

Main Data

Tonnage	85,504
GT	33,032
NT	123,602 t
Deadweight	277.58m
Length o.a.	264.50m
Length b.p	46.00m
Breadth	22.90m
Depth	14.90m
Draught	15.4 kn
Speed	

Propulsion

Two dual-fuel two-stroke diesel engines Hyundai-Winterthur Gas & Diesel 6X52DF, directly acting on propeller shafts, two Wärtsilä controllable pitch propellers
Auxiliary engines:
Main generator steam turbine Mitsubishi 3,600 kW, two Wärtsilä diesel generators 9L34DF, Cummins VTA28-M2/-D(M) emergency generator

Equipment

Two forward, one aft azimuth manoeuvring thrusters Brunvoll AR100, two forward transverse thrusters Brunvoll FU93, main generator steam turbine Mitsubishi 3,600 kW, exhaust gas-heated auxiliary boiler Mitsubishi, oil/gas-fired auxiliary boiler Mitsubishi, auxiliary donkey boiler Kangrim, VOC recovery system.

MV »Amwaj«

**General**

Builder	Hyundai Mipo Dockyard Co., Korea (South)
IMO no	9917892
Call sign	HZKX
Flag	Saudi Arabia
Port of registry	Dammam
Vessel type	Chemical/products tanker
Delivery	February 7, 2023
Owner	National Chemical Carriers, Riyadh/Saudi Arabia
Managing owner	Mideast Ship Management

Classification Lloyd's Register Machinery ✱ LMC IGS UMS BWTS Hull ✱ 100A1 Double Hull Oil and Chemical Tanker Ship Type 2 CSR ESP ShipRight(CM ACS(B)) ✱IWS LI CRM (Cargo Residual Minimisation NOx3 SEEMP TC (Enhanced Tank Cleaning) SHIPRIGHT (BWMP(S,T) IHM-EU SCM SERS VECS-L Digital AL2 SAFE SECURITY (Navigation System Cargo System and Machinery System))

Main Data

Tonnage	33,817
GT	14,334
NT	55,202 t
Deadweight	

Length o.a.	183.06m
Length b.p	174.90m
Breadth	35.00m
Depth	19.30m
Draught	13.02m
Speed	15 kn

Propulsion

Two-stroke diesel engine, directly acting on propeller shaft

Equipment

Two enclosed lifeboats, Oriental hose handling crane

SMM sets more priorities with AI and repair and retrofits

EXHIBITION / CONFERENCE PROGRAMME | SMM, the world's leading maritime trade fair, opens its doors on September 3rd. For the 31st time, representatives and experts from all over the world will come together in Hamburg.

Starting this year, the accompanying SMM conference programme will take place free of charge on the stages within the exhibition. According to Ulrich Selbach, head of the Maritime and Technology Fairs at Hamburg Messe und Congress (HMC), the recipe of success of SMM lies in the fact that the exhibitions and conference programme tracks down and picks up on the latest industry trends every two years.

New this year is the so-called 'AI Center', which will create a separate area for mari-

time applications using artificial intelligence. For investors, entrepreneurs and technology enthusiasts, the AI Center in Hall B6 offers an excellent opportunity to find out about the latest developments and become part of the dynamic AI community, the organisers said. Within the framework of this focus, the "AI for the Oceans Award" will be presented on the Thursday. Already in the run-up, the international jury selected blueOASIS, HUB Ocean and OceanOS as finalists. With this selection, the jury acknowledges that monitoring and data analytics are the most urgent tasks for AI to improve ocean health. In addition to ocean monitoring, the applicants covered a wide range of topics, from fighting illegal fishing and plastic pollution to optimising shipping routes, fish farming, and autonomous vehicles.

Also for the first time, the topic Repair and Retrofit will hit centre stage with a dedicated session on the Green Stage on Thursday, from 04:10pm to 04:45pm. Titled "Decarbonising the fleet: the importance of the repair and retrofiting business - current projects and prospects", the panel will see representatives from a shipping company, a shipyard, a supplier company, a classification society, a system integrator and a software developer to cover the entire spectrum of the market.

The session has been organised and will be moderated by the editorial team of DVV Media's Ship and Offshore Repair Journal.

The entire programme and more information about SMM 2024 can be found at <https://www.smm-hamburg.com/>

RETROFIT RESEARCH PROGRAMME:

Reduce your emissions with a range of retrofit solutions from engines to wind-assisted propulsion



Book a meeting



Explore options to decarbonise your fleet at **SMM, Hall B2, Booth No. 198**

Lloyd's Register and variants of it are trading names of Lloyd's Register Group Limited, its subsidiaries and affiliates.

Copyright © Lloyd's Register Group Limited, 2024. A member of the Lloyd's Register group

ABB Marine & Ports

The technology company ABB Marine & Ports is looking forward to discussing the efficiency and reliability needs of shipowners today and the demands of tomorrow with visitors to its stand at SMM 2024. ABB representatives will be available to discuss a wide range of vessel types and the services offered by the company, spanning from grid to propeller, and ship to gate. These include propulsion, electric and hybrid technologies, as well as various digital innovations. The company's experts will be able to address inquiries about Azipod® electric propulsion, ABB Dynafin™, ABB Digital services, ABB Decarbonization services, and ABB's service network. A special focus will be placed on the ABB Ability™ Routeguard service, which is the latest addition to the company's diverse portfolio for maritime customers. In June, ABB introduced Optimal Speed Routing functionality to its routing services.

Hall B6, Stand 329

This feature enables vessel owners to optimise the vessel's route and speed simultaneously to manage fuel costs on a through-voyage basis. It is the first application in the market equipped to optimise track and operating speeds simultaneously against anticipated weather. This also represents the first upgrade to the ABB routing portfolio since the company acquired the shipping business of DTN Europe BV and DTN Philippines Inc in January. Optimal Speed Routing advises operators of any changes they should make to the vessel track or speed to avoid heavy weather, utilising the latest available meteorological information and real-time inputs like vessel daily hire costs, fuel costs, and user-defined vessel performance models. This advisory aims to minimise fuel consumption on calculated routes to cut costs and reduce emissions.

<https://new.abb.com/marine>

Alfa Laval

The provider of sustainable systems for the maritime industry, Alfa Laval, will showcase various products of its range at this year's SMM. Alfa Laval offers several ways to save fuel and enhance ship operations by addressing the diverse needs of future fuels, boosting onboard energy efficiency, and improving EEDI/EEXI and CII.

They include the new energy-efficient AQUA Blue E2 freshwater generator, the OceanGlide air lubrication system and the innovative Oceanbird wind sail – a joint venture between Alfa Laval and Wallenius. Alfa Laval's Micro WHR and E-PowerPack make it possible to use waste heat as an additional source of energy.

Hall A1, Stand 226

The Swedish company is also focusing on digitalisation. StormGeo, part of Alfa Laval, will present its digital applications for route optimisation, weather and fleet performance. The variety of digital tools helps shipping companies and shipowners reduce pollution and comply with environmental regulations.

Alfa Laval is working with customers and partners to make shipping more sustainable – and has its own environmental goals in mind. For example, the independent Science Based Targets Initiative (SBTi) has confirmed the group's progress towards zero emissions by 2050.

www.alfalaval.com/

Bachmann electronic GmbH

Hall B6, Stand 307

At SMM, Bachmann electronic will be presenting its expertise in open standards for maritime applications. Among other things, the focus will be on the integration of the various elements within a control system using module type packages (MTP), data distribution service (DDS) and open bridge architectures. Among the new products to be presented at the trade show are the OTC1300 panel PC, an improved version of the GMP232 controller-integrated grid measurement and protection module, and the I/O system M100. Bachmann electronic will also showcase the 2.0 version of its Smart Power Plant Controller (SPPC). The updated product includes extended control processes and supports the integration of various energy sources in an overall system, for example for supplying energy to a ship.

Cyber security will be another focal point of the company's presence in Hamburg: the OPC UA server of the M200 controller now offers end-to-end encryption, making old standards such as FTP obsolete. This makes it more resistant to hackers carrying out cyber-attacks on ships, port or offshore facilities, Bachmann said in a statement.

www.bachmann.info/en



Source: Bachmann

Bachmann electronic will be at SMM 2024 to present its expertise around open standards

Anschütz GmbH

Anschütz, a Kiel-based specialist in navigation and bridge systems, will be exhibiting its entire portfolio for safe and efficient navigation – from gyrocompasses to fuel-saving autopilots, from steering control systems to integrated navigation systems (INS), and from today's innovations such as the electronic logbook to tomorrow's innovations in autonomous navigation. All Anschütz products at SMM also fulfil the cyber security standards of IACS.

With the new NautoPilot 5000 NX, Anschütz will be showing an autopilot that features proven high-precision steering algorithms and also offers a broad range of fuel-saving functions. To achieve optimum efficiency in terms of fuel consumption and emissions, NautoPilot 5000 NX combines automated functions such as an adaptive ECO mode or course control and the brand-new toe angle function with an intuitive assessment of the actual steering performance.

Hall B6, Stand 304

With the electronic logbook eLog, another innovation has matured and will be demonstrated for the first time at SMM with its fully expanded range of books and functions. Visitors to the stand will be able to see a full demonstration of the eLog and arrange a free trial. Synopsis Ins comes with the latest software version which introduces a range of smart functions, particularly on the Electronic Chart Display and Information System (ECDIS).

www.anschuetz.com

BASSnet

Hall B6, Stand 532

Founded in 1997 and of Norwegian heritage, BASSnet is a global provider of ERP maritime services for shipowners and managers, operators of rigs and floating productions, storage and off-loading vessels (FPSOs), as well as offshore units. The company has enhanced its BASSnet Fleet Management Systems with powerful new features for greater control, flexibility and efficient fleet operations. At SMM, the fully revamped BASSnet Inventory App can be experienced first hand. The app is designed to enable seamless

digital stock management onsite, allowing users to view and update inventory details swiftly and accurately, all from their mobile devices.

Additionally, the company has upgraded its portfolio with the BASSnet Business Intelligence (BI) Dashboard. This tool provides more analytics dashboards for deep and valuable insights covering the major maritime areas. For effective audits, inspections and findings reporting, BASSnet has also improved its BASSnet Safety & Quality App. www.bassnet.no

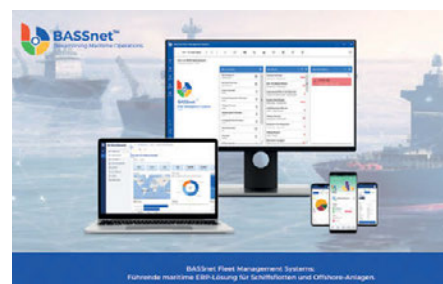

BASSnet has enhanced its BASSnet Fleet Management System

Source: BASSnet

Baumüller Anlagen-Systemtechnik GmbH & Co KG

Hall A4, Stand 411

Baumüller Anlagen-Systemtechnik GmbH & Co KG is the system company of the Baumüller Group. The company has already successfully converted numerous workboats, tugs, inland waterway vessels and yachts to hybrid and all-electric drive systems. With its wide range of products and services, from motors, converters, and control units to charging systems, diagnostic software, and links to battery management systems and fuel cells, Baumüller is well established

in the smart shipping sector. The marine portfolio is supplemented by a variety of new products such as the BAS-PCS power management system and the BAS-Link DC-Grid power distribution platform, which will be presented at this year's SMM. Baumüller is also applying its engineering expertise to its range of charging infrastructure products with a customised system architecture. All marine applications are offered not only as original equipment, but also as retrofits. Com-

prehensive services for maximum runtimes and smooth operation round off the marine portfolio. For electric ships with battery-powered electric motors, hybrid drives for e-fuel generators with electric motors and parallel hybrid ship drives with synchronous electric and main motors, Baumüller handles all the engineering for propulsion and power generation: generators, drives for propellers and bow thrusters, the power distribution system, and onboard power generation. www.baumueller.com



Protecting environment & enhancing flexibility with REINTJES Hybrid System

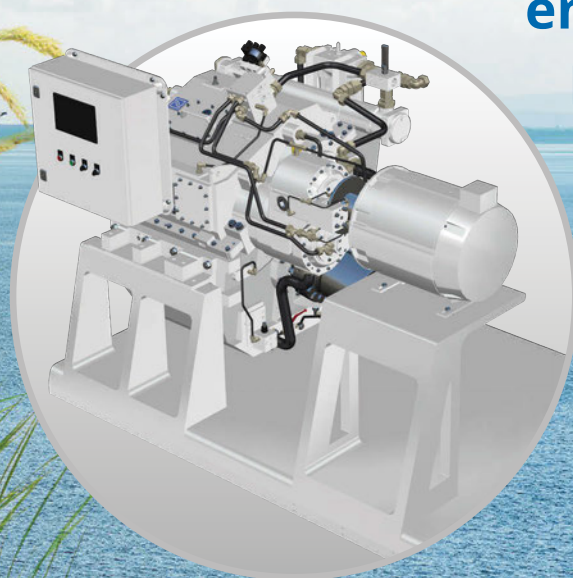

For more information visit us at the SMM - hall A4 booth no. 211

www.reintjes-gears.com

Becker Marine Systems GmbH

Hall A1, Stand 223

Hamburg-based Becker Marine Systems GmbH, a provider of manoeuvring systems and energy-saving devices for the maritime industry, will unveil two new product segments at SMM 2024. They are aimed at optimising vessel hydrodynamic performance. Details will be revealed by managing director Henning Kuhlmann at a press

conference on Wednesday, September 4th, at 11:00 a.m.

In conjunction with the product launches, Becker is relaunching its corporate design and website, reflecting its forward-thinking approach. The new website will offer easy access to information about the company's network, products, and services.

Visitors to SMM will find Becker Marine Systems at stand 223 in hall A1, together with strategic partner Nakashima Propellers. The booth will provide an inviting space to learn about the company's manoeuvring and energy-saving solutions, with the exhibition team available to answer questions.

www.becker-marine-systems.com

Bender GmbH & Co KG

Hall 6, Stand 152

The sometimes extreme conditions at sea require special applications for the power supply on board. Monitoring systems are designed to prevent total failures and facilitate troubleshooting. Therefore, the German company Bender will present the RCMS150, a monitoring module that is suited for use in earthed electrical systems on board, at SMM 2024. It can monitor six channels simultaneously for residual currents, can be installed directly in the control cabinets and offers a bus connection (Modbus RTU) to the ship's network. With the RCMS150, faults in the power supply can be localised quickly and easily.

In addition, the new GM401 generation of devices ensures a reliable shore power sup-

ply in the harbour. It permanently monitors the protective earth conductor (PE) of the shore connection in accordance with IEC 80005-1. The GM401 ensures that if the PE is interrupted by ship movements, tidal range or other influencing factors, the power supply from the shore is interrupted. This prevents the short-circuit current from being discharged via the ship's hull or gangway in the event of an electrical fault on board and putting passengers and crew in danger. The GM401 can be used for medium-voltage and low-voltage applications and can be easily mounted on the top-hat rail in the control cabinet of the shore connection.

www.bender.de

böhm Kabeltechnik GmbH

Hall B6, Stand 603

Visitors to the stand of böhm Kabeltechnik GmbH will have the opportunity to explore the Iserlohn-based company's highly specialised marine cables with VG 95218 60-66 approval. With this approval, the marine cables fulfil the highest safety and quality standards, making them the ideal choice for shipbuilders, shipping companies and offshore plant operators who depend on reliability and safety.

Regarding their resistance to oils, UV radiation and mechanical stresses, the cables are particularly durable, which significantly reduces maintenance costs, the frequency of replacements and increases cost-effectiveness. This robustness improves operational safety and at the same time offers optimum performance for the transmission of power and signals in demanding maritime environments. The marine cables can be used universally and are suitable for a wide range of applications in the maritime sector, from communication systems to power supply. These marine cables have already proven themselves in renowned marine projects, which underlines their performance and reliability in real-life deployment scenarios.

www.boehm-kabel.de/en/



Bender will present the monitoring module RCMS150

Source: Bender GmbH & Co KG

Berg Propulsion

Hall A4, Stand 316

At SMM 2024, Swedish company Berg Propulsion will showcase its latest range of propulsion technologies, as well as its electrical integration and energy efficiency optimisation tools for commercial and naval vessels. Berg Propulsion has large expertise in designing and manufacturing controllable-pitch and fixed-pitch propellers, azimuth thrusters, transverse thrusters, and control and maneuvering systems. In the initial vessel design phase, Berg evaluates propulsion

concepts by applying in-depth analysis of vessel performance. These assessments analyse capex, opex, payback period, performance metrics, emissions levels, fuel consumption rates, and potential enhancements. Customers are given the opportunity to select the desired level of electrification, ranging from conventional engines with direct drive to the innovative options of Berg Fuel Electric, Hybrid Electric, and Fully Electric. During SMM, Berg Propul-

sion will be demonstrating its comprehensive approach to retrofit options, aimed at assisting owners in achieving significant improvements in fuel efficiency and performance. By employing a thorough analysis of vessel performance, Berg Propulsion is able to develop a range of retrofit and upgrade options that not only align with upcoming regulations but also serve to extend the vessel's life cycle.

www.bergpropulsion.com/



OceanGuard® FGSS



OceanGuard® LFSS



OceanGuard® EGCS



OceanGuard® CCUS



OceanGuard® BWMS



BILGE SEPARATOR



W/G HEATING SYSTEM

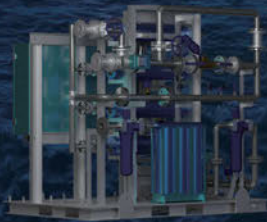

NITROGEN GENERATOR



VDR/S-VDR



MEET HEADWAY AT BOOTH A1 229 IN **SMM 2024**

HEADWAY TECHNOLOGY GROUP CO., LTD.



Methanol Fuel Supply System



LNG Fuel Gas Supply System



Ballast Water Management System



Exhaust Gas Cleaning System



Carbon Capture Utilization and Storage System



Email: info@headwaytech.com

<http://en.headwaytech.com>

TEL: +86 532 8578 8888  

bound4blue

Hall A4, Stand 229



bound4blue will present its wind-assisted propulsion system eSAILS®

Source: bound4blue

Its product eSAILS®, which will be on display at the show, is available in three sizes – from 12m to 36m in height. The units work by dragging air across an aerodynamic surface, generating exceptional propulsive efficiency. “They are easy to install, simple to operate and maintain, and suitable for almost all shipping types. They can also work as an enabler for other alternative fuels, such as biofuels, as these will be expensive and therefore costs can be minimised through wind power. We’re looking forward to showcasing all these benefits, and more, to everyone at SMM”,

said José Miguel Bermúdez, Chief Executive Officer, bound4blue. Bound4blue has recently received eSAIL orders from shipping companies including Eastern Pacific Shipping, Louis Dreyfus Company, Marflet and Odfjell. The units enhance compliance with existing and upcoming regulations, including improving vessel CII ratings, boosting EEDI and EEXI, complying with the advent of FuelEU Maritime, and contributing to saved allowances within the EU Emissions Trading System.

<https://bound4blue.com/>

Brombach + Gess GmbH & Co KG

Hall B5, Stand 310

At this year’s SMM, Brombach + Gess will be showcasing innovative, energy-efficient and cutting-edge applications in ship glazing. With its flexible railing system BalustradeMove, the company will show how outdoor areas, sundecks, promenades and restaurants can be transformed into wind-protected zones. By lightly pressing the edge of the glass, the pane moves up without the need for electricity. The system can be installed as a new one or existing glass balustrades can be upgraded. Another exhibit features a 100% bonded A60 fire-resistant glazing product, presenting a visually light and attractive tool. In addition, Brombach + Gess has expanded its product portfolio in the area of interior design with

glass. The range includes interior glass doors, glass partitions, walk-on glass staircases, mirrors and decorative glass panes. The variety of interior glass designs will be demonstrated with samples that enhance interior aesthetics. The laminated panes feature a thin, translucent solar film that hardly restricts visibility. By selecting the appropriate degree of transparency, the focus can be placed on energy gain or light transmission, depending on the area and location of application. Photovoltaic glass generates energy while also providing acoustic and thermal insulation, offering significant energy savings and ensuring a comfortable indoor climate.

www.brombach-gess.de/en



Source: Brombach + Gess

Visitors to the stand of Brombach + Gess can explore the integration of an innovative solar glass (PV glass) in a glass balustrade

Bureau Veritas Marine & Offshore

Hall B3, Stand 103



Rolf Stiefel, managing director of Bureau Veritas Marine & Offshore, said: “For an emission-free future for shipping, all stakeholders must pull in the same direction.”

“We’re by your side” is the campaign that will be the focus of the classification society Bureau Veritas at the maritime industry’s most important trade fair. “For an emission-free future for shipping, all stakeholders must pull in the same direction. Everyone should share ideas and learn from and with each other,” said Rolf Stiefel, managing director of Bureau Veritas Marine & Offshore. “Bureau Veritas stands by its customers, ensures

the safety of ships and crews and works with technology pioneers for long-term decarbonisation solutions.” This promise is also kept in the new digital application “Move”, which enables customers to handle projects more efficiently. When developing the app, Bureau Veritas asked its customers in advance which aspects would best support their workflows, and involved them in the test versions during im-

plementation and took their specific feedback into account – to ensure that the application meets their wishes and requirements. Visitors can experience “Move” and the services on offer at the trade fair stand 103 in Hall B3. On the first day of SMM, Rolf Stiefel will take part in the Maritime Platform panel discussion, which is open to all visitors.

www.marine-offshore.bureauveritas.com

ClassNK

Hall B2, Stand 212

Source: ClassNK



ClassNK has published "ClassNK Alternative Fuel Insight" to provide guidance relating to future fuel selection

Classification society ClassNK will concentrate on shipping's need to reduce greenhouse gas (GHG) emissions at this year's SMM. Its primary focus will be on the tailored ClassNK Transition Support Services, designed to aid shipping clients in making a seamless transition to zero-emission operations. Representatives from ClassNK will offer visitors insights into its Transition Support Services, which focus on three types of GHG emission reduction measures: the introduction of alternative fuels for ships, energy efficiency improvement technologies, and the use of onboard CCS. In addition, ClassNK has published "ClassNK Alternative Fuel Insight" to provide guidance relating to future fuel selection, summarising the characteristics and latest trends in alternative fuels in an easy-to-understand manner.

Regardless of these measures, ship-owners and managers must monitor GHG emissions today, using a suitable management tool. To address this, ClassNK provides ClassNK MRV Portal for regulatory compliance such as IMO-DCS/EU MRV/EU-ETS/FuelEU Maritime and CII rating as well as ClassNK ZETA for visualising and effectively managing GHG emissions.

www.classnk.com/hp/en/index.html

CargoKite GmbH

Hall B2, Stand 102

The Munich-based start-up CargoKite is currently working on producing innovative, wind-powered micro cargo ships and will present its concept at this year's SMM. These vessels are under 300 TEU and are designed for the short-sea and feeder markets. With the help of a kite, actively controlled hydrofoils and intelligent route planning, the ships can make use of the wind reliably. With these high-tech sailing ships, the start-up is helping shipping companies to reduce their operating costs

by 70%, eliminate emissions and enable goods to be transported more quickly. The innovative ship design and patented control system allow their vessels to generate forward propulsion in 290° of wind direction. The self-launching and retraction system eliminates any risk of the kite's cables getting caught on the ship. CargoKite has already signed Letters of Intent with major shipping companies and their first, full-size vessel will be on the water in 2027.

<https://cobham-satcom.com/>

WOODWARD



The advertisement features a large image of a blue and red oil tanker ship at sea. In the top right corner, there is a call to action: "Visit us at SMM Sept 3-6, 2024 Hamburg, Germany" with the SMM logo. The main headline reads "P2X SYSTEM SOLUTIONS FOR A CLEANER, DECARBONIZED WORLD". Below the headline, there are images of various industrial machinery components. A list of fuel types is provided: "• METHANOL • AMMONIA • E-METHANE • ETHANOL • HYDROGEN ...". At the bottom, the website "WWW.WOODWARD.COM/WLO" is listed, and a QR code is present in the bottom right corner.

Cobham Satcom

Hall B1, Stand 501

Cobham Satcom will highlight new maritime safety technology, its diverse VSAT antenna portfolio and the latest advancements in TVRO technology at SMM 2024. The Danish maritime radio and satellite communications company will emphasise its long-standing commitment to maritime safety by presenting an innovative new GMDSS development for Inmarsat networks. The new system is designed to improve emergency communications while ensuring seamless access to the new functionality available through Inmarsat's new Safety Services. Cobham Satcom will also showcase new SAILOR and Sea Tel TVRO antennas. Designed to enhance onboard TV viewing with reliable, high-quality services globally, these new satellite TV antenna systems ensure consistent entertainment across various vessel types, from deep-sea trawlers to mega cruise ships.

<https://cobham-satcom.com/>



Source: Cobham Satcom

Cobham Satcom will also showcase its new Sea Tel TVRO antennas



Information and networking at booth A1/529 Source: DVV Media Group

DVV Media Group GmbH Hall A1, Stand 529

The team of the renowned maritime trade publications Schiff&Hafen and Ship&Offshore will once again be in charge of the daily reporting about the exhibition and conference programme in print and video format. At the stand of its Hamburg-based publishing house DVV Media, its comprehensive maritime portfolio will be on display. This SMM also marks a special occasion, as Schiff&Hafen will be celebrating its 75th birthday, highlighting the established expertise and market position of the publication.

In addition to its well-known print and digital products, some exciting news will be on display and can be discussed with the teams at the daily Meet the Press lunch between 12.30pm and 01.30pm at the DVV Media booth.

Established at the beginning of the year, the infoletter Schiff&Hafen

Kompakt offers its German-speaking readers exclusive and customised market information on a fortnightly basis.

What's more, as the publications have incorporated the Ship and Offshore Repair Journal and the Ship Repair Newsletter from the much too early deceased Mr Shiprepair, Alan Thorpe, last autumn, this newly gained expertise and knowledge will be demonstrated at the repair and retrofit session organised for the first time at SMM. Titled "Decarbonising the fleet: the importance of the repair and retrofiting business - current projects and prospects", it will be held with high-ranking international specialists on Thursday, September 5th from 04.10pm - 04.45pm on the Green Stage.

www.schiffundhafen.de

www.shipandoffshore.net

www.thb.info

Elaflex Hiby GmbH & Co. KG

Hall A1, Stand 327

Elaflex will showcase products for supplying ships with alternative fuels at SMM 2024. Hose assemblies and couplings from Elaflex for hydrogen in the low-pressure range will be featured. New DCC dry disconnect couplings and semi-automatic pneumatic nozzles for LH2 from MannTek will also be on display. Additionally, Elaflex will present DualSafe, a newly developed, double-walled hose assembly tool with sophisticated leak monitoring technology from SGB. Special rubber expansion joints and deck seals, tailored precisely to customer requirements in a wide variety of shapes, sizes, and equipment variants from ditec, will be highlighted. Composite hoses from Dantec for the safe transfer of ammonia and LNG will be displayed, as well as hose reels for different bunkering media.

www.elaflex.de/en



Elaflex DualSafe – double-walled hose assembly tool with leak monitoring technology from SGB Source: Elaflex

EPE - Environmental Protection Engineering S.A.

Hall A1, Stand 218

With more than 45 years of experience in environmental protection, EPE (Environmental Protection Engineering) provides innovative applications for sustainable maritime operations. The company is well-known for its water treatment technology, including the Poseidon Fit bilge oil-water separator and the Triton Fit physicochemical sewage treatment plant, which EPE will present at this year's SMM. EPE also designs and manufactures cathodic

protection tools under the trademark 'Polcor', which include aluminium and zinc sacrificial anodes, as well as copper-aluminium and copper-iron antifouling anodes to prevent marine growth on hulls, minimise drag, and enhance efficiency. EPE's new cadmium-free anodes are its most environmentally friendly yet. To tackle carbon dioxide emissions from shipping, EPE offers a decarbonisation portfolio that includes Amio Coriolis Flow Meters for accurate fuel con-

sumption data and improved CII ratings, and NaviPULSE VFD Upgrade to enhance the energy efficiency of various components. These applications reduce energy consumption, emissions, maintenance costs, and extend equipment lifecycles. EPE's latest addition, the ASIO range of navigational-support tools, includes a doppler speed log, echo sounder, and anemometer, promoting efficient and sustainable navigation.

www.epe.gr



EPE is well-known for its water treatment technology, including the Poseidon Fit bilge oil-water separator Source: EPE

3-6 sept 2024
leading international
maritime trade fair
smm-hamburg.com



FURUNO

Full Ahead with FURUNO Digital Transformation

Over the last few years, the shipping industry has seen a rapid increase in the use of cutting edge digital technology to visualize operational status, on-board and off-board navigation, and engine systems.

Based on the most recent advancements in marine electronics and communications technologies, Furuno is developing new technological innovations to achieve safer and more efficient autonomous ship operations.



Digital Solutions for
Maritime Navigation and Safety

Remote Control Solutions for
Offshore Equipment

See the unseen and let the AI make the right decisions and steer the vessel for you. Autonomous navigation consists of:

Recognition, which uses sophisticated equipment and unique technologies to understand the surrounding situation, this is **ENVISION**.

Decision, which analyzes the data collected to make the best decision that will allow the crew to reach their objectives safely.

Remote maintenance and management are essential to keep equipment running smoothly for a long time with various ICT and IoT solutions:

IoT Solutions: **FOP** (Furuno Open Platform) and **HermAce** (Navigation Data Sharing)

ICT Solutions: **SafeComNet** (Furuno Mobile Satellites Services)

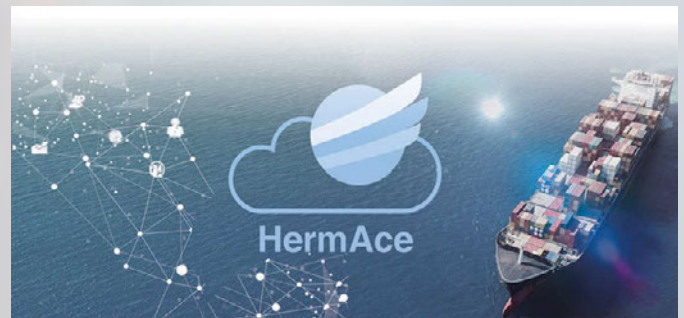

www.furuno.com

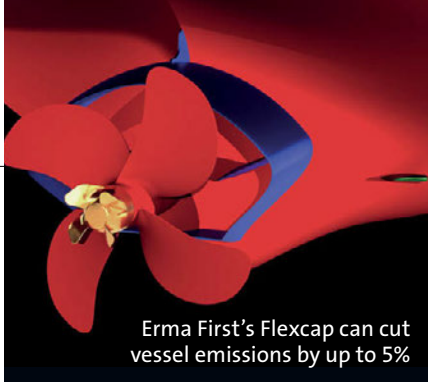

Source: Erma First

Erma First Hall A1, Stand 218

Drawing on its experience as a ballast water treatment systems (BWTS) manufacturer, Erma First has turned its attention to supporting maritime decarbonisation efforts by launching solutions that directly target enhanced vessel efficiency and sustainability. At SMM, the company will present Blue Connect, an alternative maritime power application that covers a vessel's energy demands at berth, enabling it to shut down its auxiliary engines to cut emissions, vibrations, and noise. It also enables true net-zero emissions if the electricity on shore is generated from renewable energy. Another of the company's products, Flexcap, builds on the proven capabilities of boss-cap fins to optimise ship efficiency and sustainability. By enabling fins to catch and absorb the rotating water force, it weakens the propeller hub vortex, reduces torque, and allows more energy to be channelled back into the propulsion drive train as thrust, cutting vessel emissions by up to 5%.

Erma First's latest innovation, Carbon Fit, is a carbon capture application being developed in two versions to cut vessel emissions by 15-30%. The larger system is aimed at deep-sea ships and uses established technology to absorb carbon dioxide from flue gas and store it in a liquid state, thus reducing volume, which is crucial for longer voyages. Designed for shortsea vessels, the simpler version uses an inorganic alkali agent to capture CO₂ from flue gas in a specially designed reactor, with the resultant slurry then dehydrated and stored on board until disposal at authorised facilities. The company recently launched Erma First Flow, a filterless system for newbuilds and large ships, and introduced a new platform that helps customers find the right spare parts for their BWTS. www.ermafirst.com/

Fuchs Fördertechnik GmbH

Hall A1, Stand 409

Fuchs Fördertechnik GmbH will be showcasing its wide range of products for the maritime industry at SMM 2024. The company is focusing on serving merchant shipping, cruise liners, offshore operations, navy, and mega yachts. With over 60 years of experience and a track record of 6,600 manufactured crane systems, Fuchs Fördertechnik offers versatile and flexible crane systems, including overhead cranes, monorail trolleys, telescopic crane systems, and special cranes. The Fuchs Group, which includes Fuchs Fördertechnik GmbH, Fuchs Produktionstechnik GmbH, and Fuchs Oberflächentechnik GmbH, is located just outside Hamburg and can handle the entire process from design and production to surface protection and delivery. Additionally, a globally active after-sales service team ensures proper care of the systems throughout their entire life cycle. www.fuchs-ag.de

German Association for Marine Technology (GMT)

Hall B6, Stand 145

The German Association for Marine Technology (GMT) represents companies and research institutions in the field of marine technology. It connects its members from industry and science to initiate national and international research and development projects. The GMT provides support for the development of innovative products and services, as well as in opening up new national and international market segments. Sustainable marine technology is becoming increasingly important in the context of the United Nations' Sustainable Development Goals. This involves the development of technologies for the exploration, protection, and sustainable use of the oceans.

At SMM 2024, the GMT will be part of the joint stand "German Maritime Technologies". It is also a partner of the Offshore Dialogue, themed "Sustainability needs for the ocean we want" this year. Two sessions, "Offshore energy" (10.00am to 11.00am) and "Offshore resilience" (2.00pm to 3.00pm), will take place on the Open Stage in Hall B2. Following the Offshore Dialogue, the "AI for the Oceans Award" will be presented for the first time at 3pm – an audience award and a jury prize of EUR 10,000. The award has been initiated by AI.Hamburg and the German Ocean Foundation with the support of many partners, including the GMT. On September 5th, from 4pm to

6pm, the Maritime Cluster Northern Germany and the GMT will be inviting members and representatives from business, science, politics, and the media to the traditional "Blue Hour" at the joint stand. Additionally, Canadian companies and organisations will be presenting themselves at the stand "Canada's Maritime Industries" in the immediate vicinity of the joint stand. The GMT plans to sign two Memorandums of Understanding with the Ocean Technology Council Nova Scotia (OTCNS) and the Association of British Columbia Marine Industries at SMM, continuing the successful cooperation of recent years. www.marine-technology.eu

IMES GmbH Hall A2, Stand 235

IMES GmbH from Kaufbeuren is one of the leading specialists in cylinder pressure sensors and engine monitoring systems. At this year's SMM, the company will be presenting its various electronic pressure indicators (EPM) (EPM-Peak, EPM-XP, EPM-XP^{plus} and EPM-XP^{plus-vibro}). They are battery-powered, compact and lightweight handheld devices for two- and four-stroke diesel engines that are characterised by their ease of use, robustness and high accuracy. The new generation is a further development that offers one common hardware for all EPM types. This enables a simple upgrade from peak pressure indicator EPM-Peak to engine analyser EPM-XP^{plus-vibro}. The user can purchase a license file for an upgrade to a higher version, and it is not necessary to send the device back to IMES. The collected data of all EPM types can be displayed and evaluated on the EPM visualisation software. Via USB port, the device will be connected to a PC and the visualisation software identifies the EPM type and activates the corresponding monitoring functions. Depending on the instrument peak pressure, pressure- and combustion



IMES will present its EPM versions at this year's SMM
Source: IMES GmbH

behaviour, performance data as well as valve time will be evaluated and analysed. The created measurement files can be sent to the superintendent in the shipowner's office, who can download the visualisation software from the IMES homepage free of charge. If the PC is connected to the Internet, it will be automatically checked if any firmware or visualisation software updates are available. Updates can be installed free of charge. Further new features are a larger and more comprehensive display and two additional function keys for easier menu handling.

www.imes.de/

Knaack & Jahn

Hall B5, Stand 524



Source: Knaack & Jahn

Knaack & Jahn will be located in hall B5 at stand 524

Knaack & Jahn will present its comprehensive and sustainable portfolio with a quality and full-service profile, called the 4-Dimension Specialists. These four key dimensions in shipbuilding services and modern retrofitting are piping, steelwork, HVACR and fire protection. The German company is headquartered in Hamburg, with branch offices in Bremen and Kiel. Knaack & Jahn's product and service portfolio also includes thermal oil systems,

exhaust systems, the replacement of freshwater systems, hydraulic lines and systems, as well as the installation of piping on entire decks and in fire zones. Also part of the company's service is the installation of ballast water systems, in newbuilds and retrofits.

In addition to the flushing of hydraulic systems, another new feature of the service profile is that Knaack & Jahn now provides its own flushing units, including a calibrated particle analyser. Both as part of installation and later when carrying out maintenance work, thoroughly flushing out hydraulic fluid helps prevent potentially serious damage or failures caused by contaminants.

With regard to fire-extinguishing technology, the product range includes sprinkler systems such as standard, water mist, drencher, ship- and total-protection systems, Novec1230 and CO₂ systems. The company's own KJ FireOff water mist system offers a wide variety of applications thanks to its innovative technology.

www.kj-marinesystems.com



This is how you convey sensible media effectively

Choosing the right pump optimizes the processes and reduces energy costs. NETZSCH offers:

- ✓ Individual consultation
- ✓ More than 70 years of experience
- ✓ Various pump technologies

Together we will find the optimal solution for your application.

Partnership does not end with the purchase

We support you from commissioning, maintenance up to repair and modernisation of your pump.



Visit us at the trade fair:
SMM Hamburg,
September 3-6, 2024,
Hall A2, Stand 208

NETZSCH Pumpen & Systeme GmbH
www.pumps-systems.netzsch.com

Lehmann Marine GmbH

Lehmann Marine GmbH is a German manufacturer of compact and safe battery systems for the maritime market. At SMM 2024, the company will showcase its energy storage systems Cube and Cobra. Visitors can explore a mock-up of the Cube battery system at Lehmann Marine's booth. A team of experts will answer all questions and share the latest company news, developments, and projects. Guided tours of the company's production site nearby, including transportation to and from SMM, will also be possible via prior arrangement. Lehmann Marine recently secured new

orders, including the delivery of six Cube battery systems with a total capacity of 6.6 MWh for state-of-the-art fish farming vessels in Norway and the delivery of a Cobra battery system for the first hydrogen-powered hopper dredger in France. The flexibility in configuration is combined with easy maintenance, due to small and easily accessible battery modules. The use of lithium-ferrophosphat (LFP) technology ensures not only high performance and reliability but also improved safety during operation.

<https://www.lehmann-marine.com/>

Hall A4, Stand 105



Lehmann Marine recently equipped fish farm supply vessels in Norway with six Cube battery systems
Source: Elmarin & FSV Group

Innovations for Greener Shipping

TGE Marine Gas Engineering is the leading liquified gas systems' provider specialising in cargo handling systems for gas carriers (LPG, LEG, NH3, Ethane, CO2 & LNG), FSRUs and bunker vessels, including tanks.

With our passion for innovation we are supporting the industry with technical solutions for a sustainable future, such as alternative fuels or CO2 transport for Carbon Capture and Storage (CCS) projects.

TGE Marine's broad expertise in liquefied gas- and cryogenic systems is based on more than 40 years of engineering experience in the marine industry.



Mariko GmbH

Hall A3, Stand 108

The Maritime Campus Leer – consisting of the Emden/Leer University of Applied Sciences, MARIKO GmbH and the Fraunhofer Institute for Wind Energy Systems IWES – will once again be represented at this year's SMM. At stand A3.108, experts from the GreenShipping Niedersachsen Competence Centre and the Fraunhofer Working Group for Sustainable Maritime Mobility, together with the International Windship Association (IWSA), will be presenting the latest findings and technologies relating to innovative wind propulsion systems for commercial and cargo shipping. The focus will be on wind propulsion systems, design concepts and scientific studies for emission-free shipping. Particular expertise lies in the areas of maritime hydrodynamics and aerodynamics, automation and systems technology, materials technology and the marketable development of ships with (auxiliary) wind propulsion. On September 4th, visitors can take part in Windship Day, which takes place on the sailing ship Peking, which is moored at the German Port Museum in Hamburg. Experts will present and discuss the latest technical developments in innovative wind propulsion systems for commercial shipping. Participation in the conference is free of charge. Transport between SMM and the conference venue will be provided.

<https://www.mariko-leer.de/>

MacGregor Hall A1, Stand 330

MacGregor is a cargo and load-handling provider whose hatch covers, cranes, deck machinery, RoRo and other equipment include over 50 brands. Around 40,000 vessels worldwide feature at least one of these products. Supported by knowledge from approximately 1,000 experts and 40 service centres in 31 countries, MacGregor's applications span the merchant and offshore sectors, providing fast, safe and clean workflows for vessels, and products that are streamlined for installation by shipbuilders and optimised for service support. At SMM 2024, MacGregor presents some of them, including MacRack Electric Hatch Covers, the CargoBoost tool to increase the carrying capacity of container ships, autonomous cranes, the fully automatic twist lock 'Hippo', and GravityVibe™ – the new gravity self-unloading system that enhances flexibility and efficiency in bulk handling. <https://www.cargotec.com/>

Martechnic GmbH

Martechnic GmbH has been an expert in oil quality management since 1997. The family-owned business provides engineers and users with innovative technical applications for onboard proactive and preventive condition monitoring of fuel, lube and hydraulic oil as well as cooling water. At SMM 2024, Martechnic will be showcasing its patent-pending test device MT Coolant Check designed for regular assessment of the engine coolant quality in the global shipping sector and beyond. Instead of traditional chemical-based, complex analysis of individual coolant parameters (chlorides, nitrite additives, pH etc.), the MT Coolant Check uses a chemical-free, environmentally friendly measurement method. To determine the anti-corrosion effect of the coolant in use, just one single test is conducted by means of the electrotechnical apparatus, with constant (corrosion-resistant) and working/changeable (corrosion-prone) electrodes

in a simulated engine cooling system. All the evaluation is carried out automatically, delivering results in just 15 minutes.

By offering precise and timely maintenance recommendations, the test device helps avoid unnecessary coolant changes and wastage. Easily recyclable electrodes with no shelf-life limitations contribute to waste reduction, minimising environmental risks, especially to marine ecosystems, thereby marking a significant stride towards sustainable predictive maintenance in the maritime industry.

www.martechnic.com

The patent-pending test device MT Coolant Check



Source: Martechnic

Maritime Cluster Northern Germany (MCN)

Efficient ship operation is a decisive lever for ensuring more environmental protection in shipping. For this reason, the Maritime Cluster Northern Germany (MCN), together with industry experts, has developed a guide for ship efficiency that will be available in an updated version just in time for SMM 2024. The aim of the guide is to provide an overview of existing regulations in international shipping and to highlight technical options for improv-

ing ship efficiency that are relevant for both newbuildings and existing ships. New additions include topics such as ETS trading, which has been extended to include the shipping industry at the beginning of the year. The FuelEU Maritime regulation, which comes into force in January 2025, is also covered for the first time. A number of innovations have been included in the guide in response to the ever-evolving market for new technolo-

gies that make shipping more efficient. Carbon (dioxide) capture was added as a topic, as has a chapter on changes in ship design over the past two decades. Furthermore, the fuel matrix has been revised to compare the impact of different fuels on engine availability, tank space requirements and bunker availability.

The updated MCN Guide Ship Efficiency will be available free of charge from September 2024. www.maritimes-cluster.de/en/

Hall B6, Stand 154



Your partner in the journey towards a net-zero future

RINA.ORG Our experience. Your growth.

RINA

visit us at **SMM**
hall B4.EG
booth n. 310

Metis

Specialised in Advanced Performance Evaluation Analytics, based on High-Frequency data, Metis is coming to SMM 2024 showcasing a bold rebrand and a completely revised platform. The upgraded Metis platform features additional information layers, advanced filtering and intuitive navigation in a new 'look and feel'. It includes redesigned dashboards that enhance overviews of key performance indicators in domains including emissions, optimised operations and machinery condition. It also incorporates a new Metis 'Data Health' indication, which evaluates data based on validity, completeness and timeliness. The company has developed functionality that is specific to owner compliance needs



New Metis launch artwork

Source: Metis

(EEXI, CII, DCS/MRV, EU-ETS, Shapoli, etc.), with analytics that can integrate with voyage planning and draw on weather prediction services to optimise fuel oil consumption, ETA and carbon intensity. Metis is also active as a collaborative industry partner, with examples including its work with Kongsberg Digital and turbocharger maker Accelleron. It has been part of key R&D initiatives, including the EU-backed

Hall A1, Stand 218

Engimmonia project to test clean shipboard energy tools, with a focus on ammonia as an alternative fuel, waste-heat recovery, renewables and energy-management systems. The company is working with MTI Co Ltd Singapore Branch and the Agency for Science, Technology and Research (A*STAR) in Singapore to advance the use of AI for the predictive modelling of ship emissions. Metis is also cooperating with The Cambridge Centre for Advanced Research and Education in Singapore (CARES) and Laskaridis Shipping Co. Ltd to evaluate the real impacts of future fuels on maritime decarbonisation.

www.metis.tech/

Navtor



Navtor produces data-driven applications for enhanced efficiency, performance and decarbonisation

Source: Navtor

Based in Egersund, Norway, marine technology company Navtor acquired Voyager Worldwide last year to expand its offerings of e-navigation, performance monitoring and optimisation and smart shipping innovation. It now has products and services on over 18,000 vessels worldwide. That acquisition was followed by the purchase of AI and IoT specialist Masterloop in June, supporting the team's drive towards data-driven applications for enhanced efficiency, performance and decarbonisation for shipowners and operators. The business growth has fed into products, services and

Hall B7, Stand 407

ambitions at Navtor, as the company eyes lasting industry impact. At its core, Navtor delivers a connected digital ecosystem that unites ships, fleets and management teams, harnessing the huge power of data. At SMM, visitors can experience digital logbooks, e-navigation applications, the evolving NavFleet (performance) platform, and the latest all-important S-100 developments from the expert team. Visitors will also find information about the GASS project – an AI-powered ship efficiency project that could save fleets 20% of their emissions in the future.

www.navtor.com/

Noris Group GmbH

Nuremberg-based Noris Group GmbH has been supplying innovative measurement and automation technology manufactured in Germany for 100 years. The comprehensive portfolio offers customised service for modern ship applications, which will be presented at this year's SMM. This includes alarm, monitoring and control systems for engines, generators and auxiliary systems. These enable continuous monitoring and rapid response to critical machine conditions in order to maximise operational safety. Furthermore, the wide portfolio offers propulsion control systems, that provide precise control and monitoring of drive units to enable accurate control and optimised performance. Additionally, the energy management and

power management systems ensure optimum distribution and utilisation of energy on board to increase efficiency and profit-



Noris Group will showcase its comprehensive portfolio of modern ship applications at SMM 2024

Source: Noris Group GmbH

Hall B6 Stand 316

ability. The remote access and telemetry system enables remote machine data monitoring and offers innovative remote service for maximum flexibility and fast problem-solving. To round off the portfolio, Noris Group provides speed, temperature, and acceleration sensors for maritime applications, ensuring precise measurements under demanding conditions. Its automation applications for OEMs involve the integration of customised tools for engine and transmission manufacturers, optimised for specific requirements and operating conditions. Finally, the main switchboards for power distribution further enhance the comprehensive offerings of Noris Group GmbH.

www.noris-group.com/de/

Optimarin

Hall B7, Stand 308

The Norwegian manufacturer Optimarin has further enhanced the capability of its ballast water treatment system (BWTS) with advanced UV technology.

The company's experts want to inform visitors at this year's SMM about the future of ballast water treatment. The technology lift, which follows the Norwegian player's acquisition of Hyde Marine from De Nora Marine Technologies earlier this year, marks the latest evolution

of Optimarin's high-specification BWTS after a series of innovative upgrades since the first system was delivered in 2000.

"Having a properly maintained and well-functioning BWTS installed on board has become a vital prerequisite for efficient compliance to keep ships running amid tightening regulation," said Optimarin CEO Tore Svanheld.

Optimarin has taken over service and support responsibility for some 600 systems with for-

mer customers of Hyde Marine, in addition to its own installed base of 1,400 systems, to demonstrate the company's long-term commitment to the BWTS market.

"This expansion of the core business is part of our strategic growth ambitions that also entail diversification of our product portfolio to include oily water separators and sewage treatment plants," said Svanheld.

<https://optimarin.com/>

Reintjes GmbH

Hall A4, Stand 211

The Hamelin-based gear specialist Reintjes will once again be present at the world's leading maritime show. Among other things, visitors to the stand will have the opportunity to explore the new down-angle gearbox with beveloid gear stage, WVSA 1542, as it will be exhibited in its original size. The stand concept also envisages that control lever and display will be on display next to the gearbox.

"This allows interested parties to see exactly

what happens during the virtual journey", said Reintjes managing director Klaus Deleroi. Additionally, the Reintjes project manager came up with the idea of an augmented reality visualisation. Using a tablet, it is possible to look inside the gearbox – including the technical simulation of various operating states.

The hybrid functionality with three main features characterises the WVSA 1542 in addition to the down-angle design. "These

are electrical energy generation, the creation of additional torque through the supply of electrical energy and purely electric driving in conjunction with an electric motor," explained Deleroi.

"The WVSA 1542 is an aluminium gearbox and is suitable for small and fast ships. We are currently equipping an Italian ferry company with it, for example," he added.

www.reintjes-gears.de

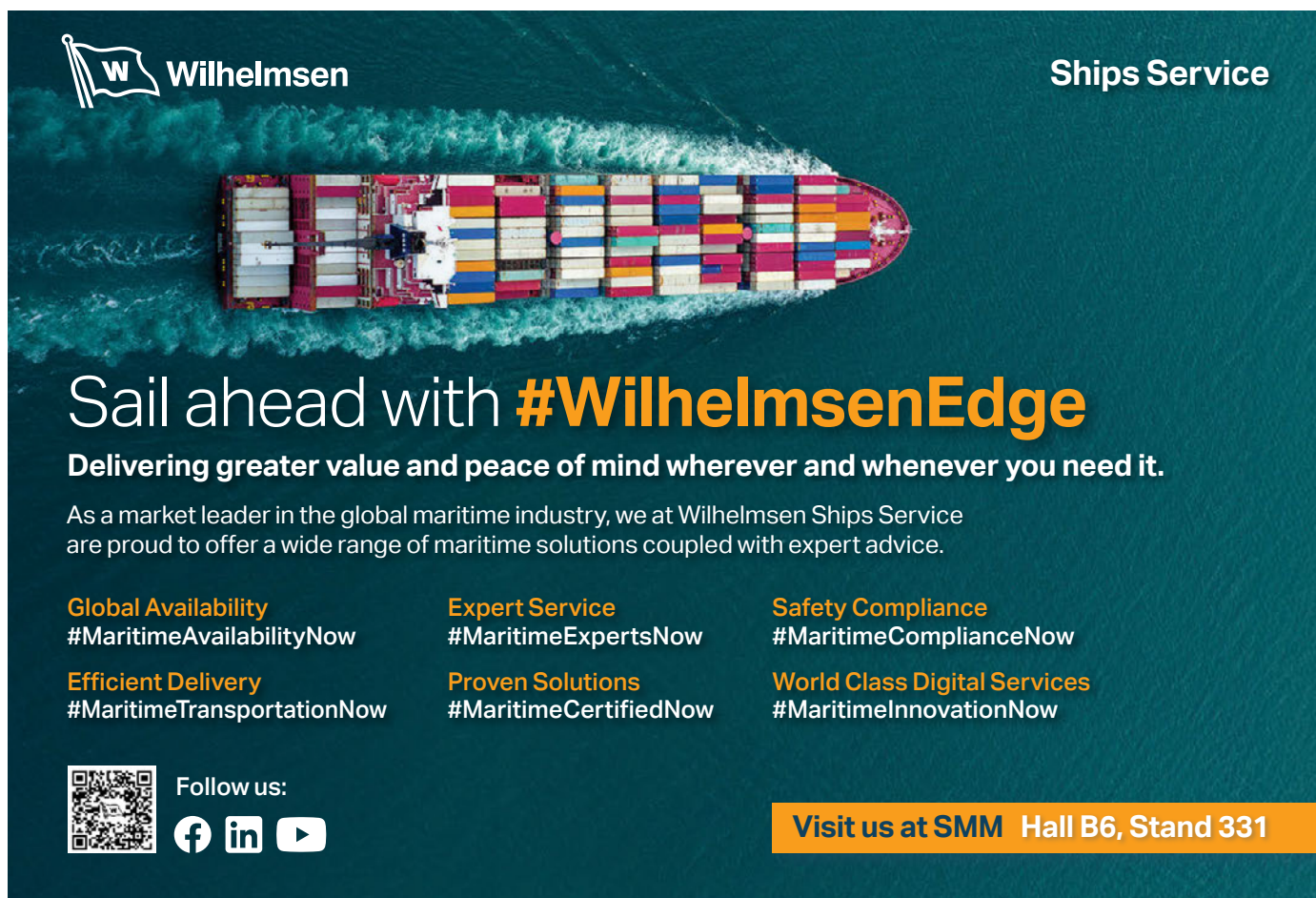



Wilhelmsen

Ships Service

Sail ahead with **#WilhelmsenEdge**

Delivering greater value and peace of mind wherever and whenever you need it.

As a market leader in the global maritime industry, we at Wilhelmsen Ships Service are proud to offer a wide range of maritime solutions coupled with expert advice.

Global Availability
#MaritimeAvailabilityNow

Efficient Delivery
#MaritimeTransportationNow

Expert Service
#MaritimeExpertsNow



Proven Solutions
#MaritimeCertifiedNow

Safety Compliance
#MaritimeComplianceNow

World Class Digital Services
#MaritimeInnovationNow



Follow us:

Visit us at SMM Hall B6, Stand 331

Rolls-Royce Power Systems

Hall A3, Stand 307

Rolls-Royce will showcase new propulsion, automation, and service tools of the mtu product brand at SMM 2024. The applications support maritime customers in the energy transition while ensuring reliable and efficient fleet operation. They include renewable diesel (HVO) combustion engines, exhaust gas after-treatment systems, hybrid systems, gas engines, automation, and bridge systems. Rolls-Royce will also present future methanol engines for CO₂-neutral operation with green methanol. The core of the Rolls-Royce mtu marine portfolio remains the internal combustion engine, with technologies like exhaust gas after-treatment and sustainable fuels aiming for net-zero emissions.

Rolls-Royce offers mtu exhaust after-treatment systems for Series 2000 and 4000 diesel engines, approved for renewable diesel/HVO. Using HVO instead of fossil diesel can reduce CO₂ emissions by up to 90%, particulate emissions by up to 40%, and nitrogen oxide emissions by up to 8%. Customers like the Golden Gate Ferry in California have successfully used HVO for years. The portfolio also includes mtu gas engines for tugs, ferries, push boats, and special ships, meeting stringent emission standards and favoured for their quiet operation and lack of vibrations, odour, and black smoke.

Rolls-Royce supports hybrid propulsion systems with the mtu HybridPropulsionPack, combining a combustion engine, batteries, and electric propulsion for emission-free operation in ports. In June, Italian shipping company Liberty Lines has commissioned fast ferries with mtu hybrid systems.

www.mtu-solutions.com

Saint-Gobain Marine

Saint-Gobain Marine is bringing together international brands to help build maritime projects. It has a specific area of expertise based on years of sector experience, whether insulation, flooring, glass, walls and ceilings, valve packages, or other applications.

Saint-Gobain Marine is focusing on sustainability, comfort (visual, acoustic, thermal), durability, design, fire safety, security and optimising total cost of ownership and installation. By joining forces, the company provides a wide range of sustainable shipbuilding materials

Hall B7, Stand 200

for different applications, while aligning IMO regulations. Visitors can meet the participating brands of Saint-Gobain Marine (Isover, Vetrotech, Weber, Kaiman, Saint-Gobain Sully and HKO) this year in Hamburg in hall B7, stand 200.

www.saint-gobain-marine.com

Schaller Automation Industrielle Automationstechnik GmbH & Co KG

Hall A3, Stand 206

Schaller Automation, a specialist in the field of safety systems for large combustion engines in maritime and industrial applications, will present CobMOS® at this year's SMM. CobMOS® is an advanced edge gateway specifically developed for sensor tools for engine monitoring, particularly the crankcase. CobMOS® integrates data from all Schaller sensors, such as Ac-

comos, Bearomos, Gasmos, as well as Visatron® VN2020 and Visatron® VN301plus, allowing for their analysis via standardised interfaces like CANopen, Modbus RTU (RS485), or MQTT (Ethernet). Its Ethernet connectivity enables seamless integration into local networks on board and onshore, allowing sensor data to be visualised on any device through a user-

friendly web interface.

A standout feature of CobMOS® is its data logger functionality, which allows sensor data to be stored on an SD card for up to three years and records threshold exceedances in separate log files. These capabilities significantly enhance intelligent analysis and condition monitoring, which are essential for modern shipping.

www.schaller-automation.com

Sero PumpSystems GmbH

Hall A2, Stand 118

At SMM 2024, Sero PumpSystems will present its new SLP high-performance pump for providing methanol to dual-fuel engines on seagoing vessels for the first time. It will be available in three versions with flow rates from 1m³/h to 30m³/h. The modular design concept of the side channel pump provides a safe high-pressure casing and was developed in accordance with the IMO-IGF regulations. Type approval from the relevant classification societies will be granted by the end of this year. Low viscosities, which are a particular challenge for many positive displacement pumps, especially at higher temperatures and high differential pressures, are easily handled with the side channel pump. The SLP pump

comes along with some key advantages such as its low, speed-independent Net Positive Suction Head (NPSHR) of 0.3m, its immunity to vibration from the ship's hull and the specially developed high-performance hydraulics. It ensures reliable, constant pressure and pulsation-free pumping of methanol

at a nominal pressure of up to 40 bar. It achieves a maximum speed of 3,500rpm and is also suitable for variable speed operation. This means constant delivery pressure can be achieved over a large volume flow range when using a frequency converter.

www.seropumps.com

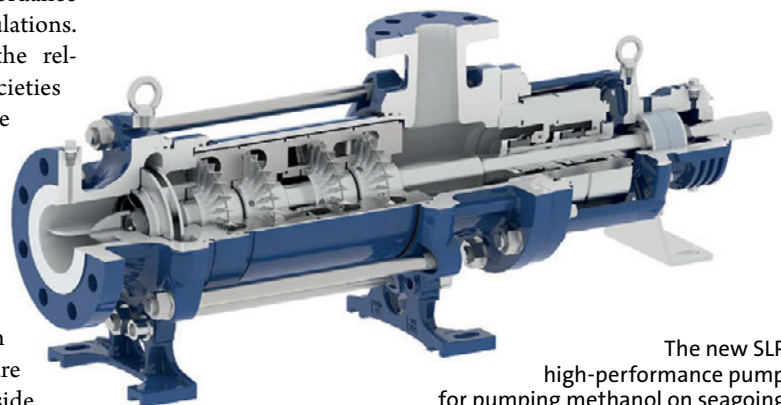

Source: Sero

The new SLP high-performance pump for pumping methanol on seagoing vessels with dual-fuel propulsion systems

QUALITY MEDIA FOR MARITIME EXPERTS

Visit us at SMM
in **hall A1 | stand 529**
and win high-quality
prizes!

www.shipandoffshore.net/smm24

Schiff & Hafen
Ship & Offshore
New Ships

SI Schiffstechnik GmbH & Co KG

Hall B7, Stand 128

SI Schiffstechnik GmbH & Co KG is a representative of high-profile ship equipment manufacturers with the focus on state-of-the-art propulsion technologies and efficient vacuum and water treatment systems, including Brunvoll AS, HamiltonJet, Jets Vacuum AS, Poloplast GmbH & Co KG and Norwegian Greentech AS.

Brunvoll's portfolio includes tunnel thrusters, even in super silent-version, RIM-driven thrusters, propulsion systems, propellers, gearboxes and automation systems, including the latest dynamic positioning (DP) systems.

HamiltonJet offers advanced and innovative waterjet propulsion systems, including control and DP systems. Brand new is the LTX Series of high-efficiency waterjets designed for medium and low-speed operation between zero and 30 knots.

Jets Vacuum AS enriches the company's portfolio with the Vacuumator® pump, a compact and reliable vacuum generator available for sanitary systems, robust and high-quality vacuum toilets, vacuum systems and wastewater treatment plants.

Poloplast GmbH & Co KG's products are a perfect match for the Jets Vacuum range, including vacuum-based PP pipes and fittings approved for maritime use.

Ballast water management systems from 25 m³/h to 1,274 m³/h are being offered by Norwegian Greentech AS.

Visitors to the stand of SI Schiffstechnik at this year's SMM will be able to use the HamiltonJet simulator. This simulator will give visitors a choice of steering capabilities to try out the impressive manoeuvrability of waterjets.

www.si-schiffstechnik.de



Visitors to the stand of SI Schiffstechnik will be able to explore the HamiltonJet simulator, among other things Source: SI Schiffstechnik

Sikla GmbH

Hall A2, Stand 209



Digitised worker assistance for the installation of pipe supports Source: Sikla GmbH

At SMM 2024, Sikla GmbH, Wilhelm Sander Handel GmbH and the Institute of Production Management and Technology at Hamburg University of Technology will be presenting an innovative tool for a smart and easy-to-use application for assembly and lo-

gistics processes. The aim is to use digital assistance systems to support workers in maritime pipe assembly using an enriched CAD model, to supply superordinate production levels with up-to-date information and to trigger and control external supply processes based on progress. This technology supports the worker in documenting the pipes and equipment components to be installed and in selecting and correctly positioning the holders based on the actual local conditions. By integrating the information into a web-based platform, the construction progress as well as the as-built status can be tracked in real time along the entire maritime supply chain. This enables precise monitoring and targeted control of material and logistics processes. www.sikla.de

Silverstream Technologies

Hall A1, Stand 413

Silverstream Technologies is a clean technology company specialising in hull air lubrication. During SMM, the London-based company will showcase its patented Silverstream® system, which shears air from air release units (ARUs) in the hull to create a uniform carpet of microbubbles that coats the full flat bottom of a vessel. This helps reduce frictional drag between the hull and the water, thereby generating 5-10% net fuel and emissions savings. It is suitable for both retrofits and newbuilds. Silverstream has an order book of over 200 vessels, with 79+ systems installed today across all segments for clients including MSC, Shell, Carnival, Grimaldi, Maersk and Knutsen. In addition to its offices in London and Shanghai, the

company has recently opened a Global Operations Centre in Southampton.

www.silverstream-tech.com/



The Silverstream® system helps save 5-10% net fuel and emissions Source: Silverstream

SRC Group AS

Hall B7, Stand 555

SRC Group is a multi-regional company with 23 years of experience in managing marine and offshore projects that require tailored products and short lead times. At SMM 2024, SRC presents its progress in Methanol Superstorage – in what the company calls a “transformative system” for methanol storage on board ships. Instead of the cofferdams traditionally used as a precaution to separate tank walls, Methanol Superstorage deploys the patent-protected sandwich plate system, from SPS Technology – consisting of a continuous polymer core injected be-

tween two steel surfaces. The 25mm-thick walls provide protection against fire or leakage that is equivalent to a conventional tank, while boosting tank volumes by 85% to provide effective mitigation for methanol's significantly lower energy density than conventional fuel. The system is also easy to retrofit. Methanol Superstorage has already received Approval in Principle from Lloyd's Register, which indicates that no conceptual issues have been identified relating to ship regulatory requirements

<https://src.ee/>

steute Technologies GmbH & Co KG

Hall B6, Stand 137

At the upcoming SMM exhibition, the steute business division Controltec will introduce an expanded range of switchgear products with DNV approvals. These switching devices have been specifically designed for applications that often involve exposure to damp and wet conditions, including salt water. Their key features include a wide temperature range (down to -60°C, depending on the series), mechanical robustness, and the ability to withstand shocks, impacts, and vibrations up to 4g. These qualities are frequently, but not exclusively, demanded by the maritime industry, for example in shipbuilding or on oil rigs. Previously, the steute range of DNV-approved switchgear consisted of magnetic sensors, safety sensors, and foot-

switches in “Extreme” variants. This range has now been extended to include three universally applicable position switch series: Ex 97, Ex 98, and Ex 99. All three series are compact and robust and can be customised to suit specific requirements by selecting different actuators. High protection class (IP 66/67) and certification for Ex zones 1 and 21 (gas Ex and dust Ex) are standard features. Additional features of these position switches include compact and standard dimensions to EN 50047 (Ex 97) and EN 50041 (Ex 98 and 99), metal enclosures (Ex 98), and universal mounting options. All three series are also available as non-Ex variants. Steute will be presenting these three switch series at SMM.

www.steute-controltec.com



steute is going to showcase three switch series at SMM 2024

Source: steute

stucke Elektronik GmbH

Hall B6, Stand 430

Hamburg-based stuckeGroup is specialised in the development and manufacture of protection and control systems for both shipbuilding and industrial applications. The multifunctional protection and control systems, which will be on display in Hamburg, offer engine control and comprehensive protection functionality for generators, motors, transformers and feeder lines. They also provide differential and grid protection, power management, DP system logics, arc protection, reactive power undervoltage protection, grid decoupling, and power plant control for LV, MV, and HV systems, gas and diesel engines, gensets, power units, and hybrid systems.

Amongst stucke’s customers are system integrators, shipyards, shipowners and managers, designers, owners and operators of power plants, sites for the generation of renewables and emergency energy systems.

stucke devices are type-certified and also comply with relevant cyber security rules. The company has offices in Germany, Serbia, India, China, Korea and representations around the globe. Product training, service, support, repair service and spare parts are available worldwide. One of the stucke protection and control devices is specially designed as a retrofit tool.

www.stuckegroup.com

Subsea Europe Services GmbH

Hall B7, Stand 232

Established at the end of 2019, Subsea Europe Services GmbH has already completed significant projects. They include the first combined hydrographic survey and underwater asset integrity mission using a mothership as a base for autonomous platforms. This was conducted at the *Deutsche Bucht* offshore wind farm in the North Sea together with Nortland Power. The company also had extensive participation in the Baltops naval exercises in 2023 and 2024. This ensures that Subsea Europe Services brings a wealth of experience to SMM as a first-time exhibitor.

Headquartered in Rostock, Germany’s North Sea marine technology hub, Subsea Europe Services will emphasise its role as

a sought-after systems integrator for specialised installations on survey vessels, research vessels, and autonomous platforms. As experts in hydrographic and related systems, Subsea Europe Services partners with manufacturers, including Sonardyne, Imenco, and R2Sonic, providing shipyards with easy access to complete integrated applications for advanced newbuild and retrofit vessels.

As a joint exhibitor at SMM with Subsea Europe Services, global underwater technology pioneer Sonardyne will focus on its systems for dynamic positioning, such as the Sprint Nav DP, highlighting its advanced technology and applications in the maritime industry.

<https://www.subsea-europe.com/>

Terasaki Electric Group

Hall B6, Stand 320

At this year’s SMM, Japanese Terasaki Electric Group is presenting a number of its key products, including Terasaki Shore Connection (AMP system), a system that switches off the ship’s generator after docking and supplies the required amount of power from shore. It will also highlight the integrated control and monitoring system TERANET50X, which minimises the impact of equipment failures by distributing standard components and integrating them over a dual-loop Ethernet network. Further key products

being showcased include the medium voltage switchgear HSS0, which maintains high safety standards while improving various current ratings and reducing the depth dimensions. Additionally, the ACB TemPower 2 offers a wide full lineup from 800A to 6300A, with the same panel cut-out for all models, simplifying switchboard design. The compact ACB TemPower PRO, ranging from 630A to 1600A, is 49% lighter and 48% smaller in volume compared with previous models.

www.terasaki.co.jp

Vaisala Hall B6, Stand 148

At SMM 2024, Vaisala, the Finnish provider of measurement instruments and intelligence for climate action, will showcase its application set to provide reliable weather insights for safe, sustainable and efficient wind-assisted shipping and offshore wind energy operations.

Wind assistance will lead shipping into a more environmentally friendly future if the wind can be utilised as efficiently as possible. At the same time, safety issues in and around offshore wind energy substations are significantly higher than on shore. While weather forecasts are more accurate and trustworthy

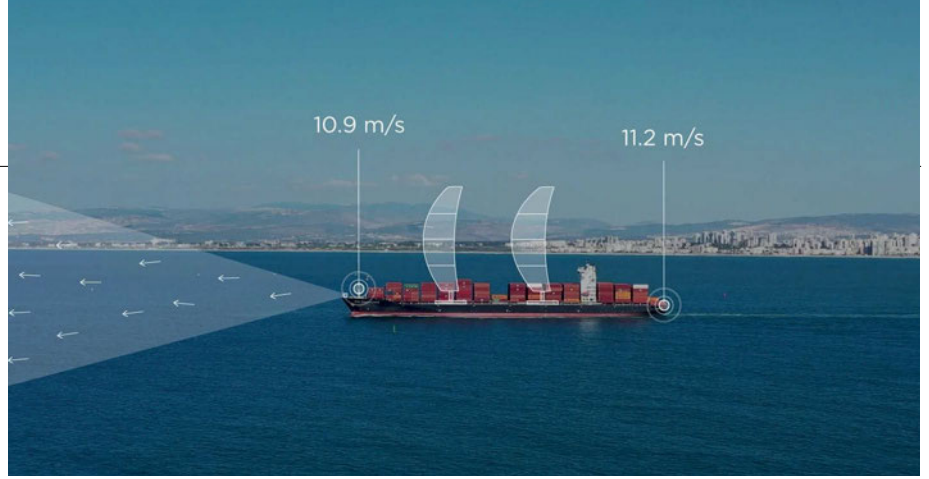

Vessel with a wind-assisted propulsion system

Source: Vaisala

on land, unexpected severe weather events take a toll in harsh offshore environments. Vaisala's maritime portfolio includes weather transmitters, wind anemometers and lidars, as well as humidity, barometric pressure, visibility and temperature sensors, global lightning detection data and weather

forecasting. They are combined with an Offshore Weather Awareness platform to deliver the hyperlocal weather intelligence, insights and nowcasting capabilities necessary to capture maximum wind propulsion and enhance safety at offshore operations.

www.vaisala.com/en

Vestdavit

Hall B5, Stand 334

Vestdavit, a Norwegian company with a long track record of innovation in boat-handling systems through continuous product development in core naval and coastguard markets, is now seeing increasing uptake of its systems in the offshore wind industry.

The Norwegian davit supplier has supplied over 80% of offshore wind operators with a range of boat-handling systems designed for safety and reliability in variable sea states.

"The proven longevity and user-friendliness of our systems are further key factors behind increasing davit demand from offshore wind," said Vestdavit's managing director Rolf Andreas Wigand.

In Hamburg, Vestdavit will showcase Mission Bay, a handling system with an in-board hangar for automated deployment of craft from either side of a vessel, which has been adopted in the offshore cable-laying segment.

www.vestdavit.no/

Viking Life-Saving Equipment

Hall B1, Stand 504

Viking Life-Saving Equipment is a specialist in maritime, offshore and fire safety, providing and servicing safety and fire-fighting equipment for passenger and cargo ships, offshore installations, fishing vessels, the navy, helicopter services, fire departments and leisure yachts. Visitors to Viking's stand at SMM can find out more about new developments in fast rescue boats and enclosed lifeboat design, PPE, including fire suits, immersion suits and life jackets, or discuss the full-scope Shipowner Agreement concept. Over 20,000 commercial vessels have their safety needs managed under the agreement with the supplier.

Earlier this year, Viking extended its range of marine evacuation systems with the acquisition of Undertun – a combined walkway-slide unit that also stores the inflatable life raft in a structure integrated into the ship-side. Featuring its own power source and activated by a single user, Undertun is designed for ferries operating in sheltered waters.

Viking also continues to win strong orders for HydroPen™ – the drill-and-spray fire-fighting device for containers in the stack. In response to growing numbers of EVs moving by ship, meanwhile, the company has agreed to distribute leading technologies such as Bridgehill fire blankets and recently launched marine fire suits that include professional-grade outer shells and moisture barrier protection against water penetration and steam burns.

www.viking-life.com

Source: Vestdavit



Vestdavit is increasing its davit deliveries to the offshore wind market

Wago GmbH & Co KG

Hall B6, Stand 318

Wago GmbH & Co KG, connection and automation technology supplier, will present its Wago Edge Controller at this year's SMM. The Wago Edge Controller has DNV approval and is offering support for collecting and evaluating all data in the marine environment, such as oil consumption or lighting control. With this product, Wago

provides maritime users an edge device with high-performance control and data processing with cloud functionalities. The Edge Controller can also be programmed via CODESYS, supports container technologies, such as Docker®, and has various interfaces from the control environment.

www.wago.com



WindEnergy Hamburg

The global on & offshore event

24 ————— 27
September 2024

Recruiting
Days
26+27 Sep

Driving the energy transition. *Together!*

Be sure to take part in the world's biggest and most important business platform for the onshore and offshore wind industry!

- Meet up with 1,500 exhibiting companies from 40 countries across 10 halls
- Get in touch with the key decision makers of the international wind energy sector
- Visit the first-rate conference programme on 4 stages in the halls free of charge
- Two days dedicated to recruiting – for career starters, specialists and career changers

windenergyhamburg.com



Organised by:



Global Partner:



European Partner:



Partners:



Wake Media Ltd

As a specialist marketing and communications agency for companies serving the marine and energy industries, Wake Media



Wake Media will host a network event during SMM 2024

Source: Wake Media

Hall B1, Stand 332

offers a wide range of services, including marketing strategy development, PR and communications, media and content production, event management, creative services, advertising and more. As the founder and curator of Marketing in Maritime, Wake Media will be hosting a networking event during SMM – a must-attend event for marketing professionals. This event offers an opportunity to connect with industry leaders and gain insights into the latest marketing trends. Details will be announced soon at www.mimcrowd.com

www.wake-media.co.uk/

Walter Stauffenberg GmbH & Co KG

Hall A1, Stand 213

Walter Stauffenberg GmbH & Co KG (Stauff) will showcase its innovative clamps for shipbuilding in Hamburg. The StauffNRCs (noise reduction clamps) are ideal for vibration-damping and noise-absorbing installation of tubes. The clamps have a specially shaped two-part elastomer insert that effectively reduces vibrations and minimises noise. The special contour of the insert makes it possible to attach tubes with different diameters for each clamp size, which opens a variety of application options.

Stauff has been expanding the range of available materials to allow for the increasing complexity of hydraulically operated systems. Clamps made of flame-retardant materials in line with international guidelines and standards or products with different shore hardnesses, for example, are offered for absorbing vibrations as well as to ensure a high level of structural integrity.

The “2+5 system” from Stauff additionally reduces the installation space for the hydraulic line system, which can have significant advantages in the shipbuilding environment. The system enables efficient fastening of multiple lines with different diameters on a single weld plate, offering a space-saving and flexible solution. In addition to other product highlights, the manufacturer will also present the Stauff Bond System, which enables secure attaching of the Stauff clamps, particularly in areas where welding is not possible or only with great effort.

<https://stauff.com/de/>

Weicon GmbH & Co KG

Hall B5, Stand 133

Weicon GmbH & Co KG, established in 1947, has developed a permanently elastic adhesive and sealant for the construction, maintenance and repair of ships – the Flex 310 M FireSeal, which it will showcase this year in Hamburg. The SMP-based adhesive and sealant is flame-retardant and can withstand fire for up to 120 minutes. It is tested and classified for all joint structures according to EN 1366-4. The paint-compatible sealant with very low volume shrinkage meets the requirements of the International Maritime Organisation IMO FTPC Parts 2+5 as well as for rail vehicles in accordance with DIN EN 45545-2 R22/23 HL3. The very low emissions allow for safe indoor application. It is low-odour and contains no solvents, isocyanates or silicones. FireSeal adheres very well even to powder-coated, painted, galvanised, anodised, chromated

and hot-dip galvanised surfaces. It is suitable for use on metal, many plastics, concrete, and wood. It can be used for fire barriers and covers, for joints in non-structural components with fire resistance requirements, connection joints, or for sealing cable ducts, pipe openings, and housings. www.weicon.de



The Weicon Flex 310 M FireSeal allows for safe indoor applications due to its low emissions

Source: Weicon GmbH

Wiska Hoppmann GmbH

Hall B6, Stand 212

Wiska Hoppmann GmbH, based in Kaltenkirchen, will be exhibiting its range of lighting, electrical installation material and video surveillance products at this year's SMM. With its 4010 and 2010 LED multi-purpose luminaires, Wiska offers compact and flexible products with a long LED lifetime and material advantages for sustainable installation for technical outdoor lighting. They are complemented by the new LED floodlight 5010, a product in addition to the LED floodlight 5000 with High-Lumen-Output, 1x 220W or 2x200W and separate ballast unit. The new Wiska LED searchlight extends the octagonal

design series and can be used as a searchlight or floodlight with 2x 18,000 lm and IP 66/68, in endless rotation, with stepless speed and morse function.

The Wiska HNA installation material made of brass were the first Wiska products the company built. A few years later, the first plastic products were added, especially for the non-maritime market. Wiska now offers a high-quality, seawater-resistant plastic alternative for the classic maritime brassware – lead-free and even in protection class IP66/67. The Combi® Maritim 304 system consists of a junction box, rotary switch and LED light –

manufactured from polypropylene and TPE in twin-shot injection molding in Kaltenkirchen, supplied in black and with Wiska cable glands ESKV (junction box and rotary switch). The company will also be showcasing its Varitain® reefer container sockets and cable entries at SMM 2024.

The lighting and installation ranges are rounded off by Wiska CCTV video surveillance: the current CS-S camera series with its 360° pan/tilt unit or as a fixed camera housing offers 512x zoom at 4-megapixel resolutions in operating temperatures between -30°C and +55°C.

www.wiska.com/en/11/home/



International Association of Ship Repair Agents

CABEKA House, 2 Grasscroft, Furzton, Milton Keynes MK4 1AS, United Kingdom, Tel: +44 1908 378822, Mob (Secretary): +44 7720074113, Email: mail@shiprepairagents.org, Web: www.shiprepairagents.org

Australia



HEMPSTEAD MARINE SERVICES

31 Mitchell Street, Putney, Sydney, NSW 2112, Australia
Mobile: +61 419880099
Email: semagent@iprimus.com.au
Contact: Iain Hempstead

COMPANIES REPRESENTED

Seatrium (Singapore)
SES Marine (Singapore)
ES Offshore and Marine Engineering (Thailand)

Baltic States

Lithuania, Latvia, Estonia, Poland, Russia, Ukraine



ORCA MARINE UAB



Silutes plentas 95D, LT-95112
Klaipeda, Lithuania
Tel: +370 46 246430
Mobile: +370 650 40900
Email: info@orca-marine.eu
Web: www.orca-marine.eu
Contact: Viktoras Cernusevicius

SHIPYARDS

ASABA Shipyard (Malabo, Equatorial Guinea);
ASMAR Shipyard (Chile);
BRODOTROGIR D.D. Shipyard Trogir (Croatia);
CARENA (Abidjan, Ivory Coast);
CHANTIER NAVAL de MARSEILLE (France);
COLOMBO Dockyards (Sri, Lanka);
COSCO Shipyards Group:
• COSCO Dalian (China);
• COSCO Nantong (China);
• COSCO Shanghai (China);
• COSCO Zhoushan (China);
• COSCO Guangdong (China);
• COSCO Lianyungang (China);
DAVIE (Quebec, Canada);
DETYENS Shipyard (N. Charleston, USA);
DONG SUNG Engineering & Shiprepair (S.Korea);
DAMEN Shiprepair Group:
• DAMEN Shiprepair Dunkerque (France);
• DAMEN Shiprepair Oranjewerf Amsterdam (Netherlands);
• DAMEN Shiprepair Brest (France);
• DAMEN Shiprepair Den Helder (Netherlands);
• DAMEN Shiprepair & Conversion Rotterdam (Netherlands);
• DAMEN Shiprepair Vlissingen (Netherlands);
• DAMEN Shiprepair Amsterdam (Netherlands);

SORJ (Ship and Offshore Repair Journal) takes no responsibility for the accuracy of the information in Agents Contact Directory (ACD). All information was supplied by the individual agents

• DAMEN Shiprepair Harlingen (Netherlands);
• DAMEN Oskarshamnsvärvet (Sweden);
• DAMEN Shiprepair Van Brink Rotterdam (Netherlands);
• DAMEN Shiprepair Curacao (Curacao, Dutch Antilles).
ENAVI Reparos Navais (Rio de Janeiro, Brazil);
FAMA Group (Cyprus);
GIBDOCK (Gibraltar);
HARLAND & WOLFF (Belfast, UK);
MMHE Shipyard (Malaysia);
MEC Shipyards (Panama);
NAMDOCK (Walvis Bay, Namibia)
NARP Shiprepair:
• Kiran/Erkal Tuzla (Tuzla, Turkey);
• HAT-SAN Shipyard (Yalova, Turkey);
• TERSAN Shipyard (Yalova, Turkey);
• SEFINE Shipyard (Yalova, Turkey);
• HICRI ERCILJ Shipyard (Yalova, Turkey);
• GISAN Shipyard (Tuzla, Turkey);
OMAN DRYDOCK (Oman);
SIMA (Peru);
SAN GIORGIO del PORTO (Genova, Italy);
TANDANOR (Buenos Aires, Argentina);
TSAKOS Industrias Navales (Montevideo, Uruguay);
ZAMAKONA Yards:
• Zamakona Pasaia (Spain);
• Zamakona Las Palmas (Canary Isl., Spain);

MARINE SERVICE COMPANIES

ARGO NAVIS (Greece) - Marine consulting & engineering (BWTS, SOxNOx);
CHINAPORT CLEANSEAS - de-slopping, cleaning (China);
DGS Industrial & Naval (Brazil) - afloat repairs;
ELSSI - Drug & Alcohol Testing;
MECHADINAMIK - mechanical services, Turkey
ONE NET - satellite communications, bridge equipment service;
ONE TECH - technical service;
RANDOX - Drug & Alcohol Testing;
SYM - afloat repairs & marine services.

Benelux



AVS SHIPREPAIR

Oranjekanaal ZZ 14, 7853TC Wezuperbrug, The Netherlands
Mobile: +31 6 47 952 452
Telephone: +31 85 0160 635
Email: hilka@aysshirepair.nl
Web: www.aysshirepair.nl

SHIPYARDS

EUROPE
Bulyard (Bulgaria)
Bredo Drydocks (Germany)
Gibdock (Gibraltar)
Platinum (Turkey)
NORTH AMERICA – CARIBIC
Canada East - Davie (Quebec)
Canada West - Seaspan (Vancouver)
Seaspan (Victoria)
US EAST COAST
Detyens
German Ship Repair Jamaica Ltd
PERSIAN GULF
Qatar Shipyard Technology Solutions
AFRICA
Namibia
NAMDOCK (Walvis bay)
SOUTH AFRICA
Dormac (Capetown)
Dormac (Durban)
Dormac(Saldanha)

ASIA
Korea: Orient Shipyard (Busan)
Indonesia: ASL Marine (Batam)
AUSTRALIA
Thales (NS Wales)
CHINA
DSIC Changxingdao Shipyard (Dalian)
Yiu Lian Dockyards (Hong Kong)
Yiu Lian Dockyards (Shekou)
Yiu Lian Dockyards (Zhoushan)
Qingdao Beihai (Qingdao)
Zhoushan Changhong International Shipyard Co., Ltd
Zhoushan Putuo Changhong Shipyard Co., Ltd
Ship Repair Services:
BMT (Spain)
Greentec Marine
Haïen Enc
Rotterdam Ship Repair (Netherlands)
German Ship Repair (Germany)
Offshore Inland (US /GoM)
Bludworth Marine (Houston)
Unity Marine Services (Panama)
Mapamar (Brasil)
Brightsun (Singapore)
Trident divers (Worldwide)



ESMA MARINE AGENCIES B.V.

Kuiperbergweg 35, 1101 AET Amsterdam, The Netherlands
Tel: +31 2 03 121 350
Email: shiprepair@esma.nl
Mob: +31 6 51 408 082
Web: www.esma.nl

Contact: Cees Onink (Commercial Manager)

Mobile: +31 6 22 790 463

Contact: Jeroen Goedvree (Technical Manager)

Mobile: +31 6 29 409 141

COMPANIES EXCLUSIVELY REPRESENTED

EUROPE
Kuzeystar (Tuzla/Istanbul, Turkey)
Lisnave (Setubal, Portugal)
Soby Vaerft (Soby Denmark)
West Sea Viana Shipyard (Viana do Castelo, Portugal)
MIDDLE EAST
Drydocks World (Dubai, UAE)
Drydocks World Global Offshore Services (DMC Dubai Maritime City, Shiplift)
FAR EAST
Colombo Dockyards (Colombo, Sri Lanka)
PaxOcean (Asia)
PaxOcean (Singapore)
PaxOcean Pertamina (Batam, Indonesia)
PaxOcean Graha (Batam, Indonesia)
PaxOcean Nanindah (Batam, Indonesia)
CHINA
Cosco Shipyard Group
Cosco Dalian Shipyard (Dalian)
Cosco Nantong Shipyard (Nantong)
Cosco Qidong Shipyard (Qidong)
Cosco Shanghai Shipyard (Shanghai)
Cosco Zhoushan Shipyard (Zhoushan)
Cosco Guangdong Shipyard (Guangdong)
PaxOcean (Asia)
PaxOcean (Zhoushan)
WEST AFRICA
Dakarnave (Dakar, Senegal)



AIMSS V.O.F

Snellenshof 51, 4811LN Breda, The Netherlands
Tel: +31 76 737 0002
Email: sales@aimss.nl
Web: aimss.nl
Contacts: Sami Golestanian
Email: sg@aimss.nl | Mobile: +31 6 28 96 38 48
Onno Kramer
Email: ok@aimss.nl | Mobile: +31 6 27 28 90 98

SHIPYARDS

• A&P Group (UK)
• ASL (Indonesia)
• ASMAR (Chile)
• ASYAD Drydock (Oman)
• CNDM (France)
• NASCO Group (China)
• NOSCO (Vietnam)
• SAS (South Africa)
• SGDP (Italy)
• TERSAN (Türkiye)
• TNG (Mexico)
• UNITHAI (Thailand)
MARINE SERVICES
• CROSSCOMAR (Spain), Afloat repair, Construction works, Underwater Services & Voyage Repairs
• DIAMOND SHIP (Taiwan), Store Supply
• GENERAL SHIPPING (Greece), Tank Coating Specialists, Docking Services & Turnkey Projects
• HAI HA M&S (Vietnam), Afloat repair, Construction works, Underwater Services & Voyage Repairs
• JASON MARINE ELECTRONICS (Singapore & Spain) Supply & Service of Navigation, Communication & Automation Equipment
• PBM (Croatia), Governors & ME Services, Woodward Parts & Services
• PMS (Panama), Afloat repair, Construction works, Underwater Services & Voyage Repairs
• RIDING TEAM, Supply of Qualified Welders, Fitters, Technicians, Electricians etc.
• SINGATAC (Singapore), Afloat repair, Construction, Underwater Services & Voyage Repairs
• WINKONG MARINE (China), Afloat, Underwater & Voyage Repairs
• YARA MARINE TECHNOLOGIES (Norway), Fuel optimisation, Scrubbers
• ZEBEC MARINE (India), Design, Engineering & Consulting Solution

Cyprus



WSR SERVICES LTD



234 Ayias Fylaxeos, CY 3082 Limassol, Cyprus
Tel: +357 25344418
Email: mail.cy@umarwsr.com
Web: www.umarwsr.com

SHIPYARDS

ASRY (Arab Shipbuilding & Repair Yard) – Al Hidd, Kingdom of Bahrain
ASL Marine Holdings Ltd-Batam, Indonesia
Bredo Dry Docks – Bremerhaven, Germany
Caribbean Dockyard Engineering Services Ltd (CDESL) - Trinidad & Tobago
Chengxi Shipyard Co. Ltd - Shanghai, China

Colombo Dockyard Ltd – Colombo, Sri Lanka
 CUD (Weihai) Shipyard – Shandong, North China
 Dakarnave - Dakar, Senegal
 Detyens Shipyards - Charleston, South Carolina, USA
 Dormac Marine & Engineering - Capetown/Durban, South Africa
 EDR Antwerp Shipyard - Antwerp, Belgium
 Fayard A/S - Munkbo, Denmark
 Gemak Shipyard – Tuzla, Turkey
 Guangzhou Wenchong Shipyard – Guangzhou, South China
 Harland and Wolff Heavy Industries – Belfast, N. Ireland
 Hengli Heavy Industry - Dalian, North China
 Huarun Dadong Dockyard (HRDD) - Shanghai, China
 Hutchison Ports TNG (Talleres Navales del Golfo S.A.) – Veracruz, Mexico
 International Ship Repair - Tampa, Florida, USA
 Lisnave Estaleiros Navais - Setubal, Portugal
 Lloyd Werft Bremerhaven AG - Bremerhaven, Germany
 MTG Dolphin - Varna, Bulgaria
 Netaman Repair Group - Tallinn, Estonia
 Onex Neorion Shipyards - Syros Island, Greece
 Papua New Guinea Dockyard - Papua New Guinea
 Sociber - Valparaiso, Chile
 IMC Shipyard (Zhoushan) – Zhoushan, China
 Nanyang Star Group – Zhoushan, China
 Shanhaiguan Shipbuilding Industry Co., Ltd – Hebei, North China
 Orient Shipyard Co., Ltd – Busan, South Korea
UNDERWATER AND AFLOAT
 Argus Marine Services - Columbia
 Avalontec Engineering - Singapore
 Boilerman - China, Singapore, Kobe
 Zener Maritime - India, Singapore, Rotterdam, Houston, Dubai
 ROG Ship Repair – Rotterdam
 Atlantis Marine Services LLC - Fujairah, UAE
 I-Dive Services, Singapore
 Underwater Contractors - Spain
 Resolve Marine Services – Gibraltar
 Reprosub – Las Palmas
 RIMS BV
 On site alignment
 LDM Stations in Singapore and Europe

Denmark / Finland



BSA SHIPPING AGENCIES ANS



Akershusstranda 15,
 skur 35
 0150 Oslo,
 Norway
 Contact:
 Mr. Thord Peter Mossberg
 Tel: +4723085000
 Mobile: +4792012755
 Email: peter@bsaship.com
 Web: www.bsaship.com
 Dutch Offshore (The Netherlands)
 ROG Ship Repair (The Netherlands)
 Brodogradiliste d.o.o Shipyard LP (Croatia)
 Falkvarv, (Sweden)
 Cernalva Group Algeciras (Spain)
 Hidramar S.L (Canary Islands)
 General Shipping S. A (Greece)
 TK Tuzla Shipyard (Turkey)
 Sandock Austral Shipyards, (South Africa)
 Qatar Shipyard Technology Solutions Qatar
 Unithai Shipyard & Engineering Ltd (Thailand)
 Fujian Huadong Shipyard Ltd (China)
 HuaRunDadong Dockyard Ltd HRDD (China)
 CUD (Wehai) Shipyard, (China)
 Pax Ocean Shipyard Zhoushan (China)
 First Suez Ltd - Suez Canal Transit and Shiprepair (Egypt)
 Caribbean Drydock Company S.A CDC (Cuba)



JML SHIPYARD AGENCY

Falkevägen 3,
 457 40 Fjällbacka, Sweden
 Contact: Markus Larsson, Managing Director
 Mobile: +46 702 20 37 43
 Email: markus@jmlshipyardagency.com
 Web: www.jmlshipyardagency.com

SHIPYARDS REPRESENTED

EUROPE
 Lloyd Werft, Bremerhaven, Germany
 MSR Gryfia Shipyard, Szczecin, Polen
 Sefine Shipyard, Tuzla, Turkey
 San Giorgio del Porto, Genoa, Italy
 Chantier Naval de Marseille, France
 EDR Shipyard, Antwerp, Belgium
 ASIA
 Drydocks World, Dubai
 Chengxi Shipyard, Jiangyin, China
 Zhoushan Xinya Shipyard, China
 Changhong International Shipyard, Zhoushan, China
 PaxOcean, Zhoushan, China
 Wenchong Shipyard Guangzhou, China
 Shan Hai Guan Shipyard, China
 Qingdao Beihai Shipyard, China
 DSIC Marine Services, Dalian, China
 PaxOcean, Singapore
 PaxOcean Pertama, Indonesia
 PaxOcean Nanindah, Indonesia
 PaxOcean Graha, Indonesia
 US, CANADA & CARIBBEAN
 TNG, Veracruz, Mexico
 Ciramar Shipyard, Dominican Republic
 Chantier Davie, Quebec, Canada
 German Ship Repair Jamaica
AFLOAT REPAIR/SERVICES
 Global Offshore Service, Dubai UAE
 Offshore Inland, US Gulf/Mexico
 Crosscomar, Algeciras
 UMA Marine, India
 Link Marine / Automation, UAE
 MCU Coatings
 Carell, Greece

Germany



COMBITRADE GMBH

Caffamacherreihe 7, 20355
 Hamburg, Germany
 Tel: +49(0)40 - 8080110-640
 telefax: +49(0)40 - 8080110-699
 Email: combitrade@combitrade.de
 web: www.combitrade.de
 Contact:
 Timo Schultze (+49 172 453 9610)
 Marco Löffelholz (+49 151 742 30009)
SHIPYARDS REPRESENTED
 EUROPE
 A&P Tyne (UK)
 A&P Tees (UK)
 A&P Falmouth (UK)
 Aviles Shipyard (North of Spain)
 Desan Shipyard (Turkey)
 Eiffel Industries Marine (France Atlantic Side)
 Gibdock (Gibraltar)
 MTG Dolphin (Bulgaria)
 Nauta Shipyard (Poland)
 MIDDLE EAST
 Heisco (Kuwait)
 N-Kom, Qatar
 AFRICA
 Namdock, Walvis Bay (Namibia)
 Nigerdock, Nigeria
 SAS – Sandock Austral Shipyard, South Africa
 SINGAPORE
 ST Engineering Marine (Singapore)

INDIAN OCEAN
 Colombo Dockyard (Sri Lanka)
 FAR EAST
 CHI Dalian (China)
 CHI Nantong (China)
 CHI Shanghai (Changxing + Huajing) (China)
 CHI Zhoushan (China)
 CHI Guangdong (China)
 Fujian Huadong Shipyard, Fuzhou (China)
 Beihai Shipyard, Qingdao (China)
 CUD, Weihai (China)
 CSSV Guangxi Shipbuilding, Qingdao (China)
 ZTHI (China)
 Nasco (China)
 Huarun Dadong Dockyard (HRDD), China
 CSSC Guangxi Shipbuilding + Offshore Eng., China
 DS Ship, Korea
 Huangpu Wenchong (China)
 CSBC Koahsiung (Taiwan)
 CSBC Keelung (Taiwan)
 Mitsubishi Heavy Industries (Japan)
 Hyundai Mipo Dockyard (Korea)
 Orient Shipyard CO. LTD (HQ) Busan & Gwangyang Shipyard (Korea)
 Sam Kang Shipbuilding & Conversion (Korea)
CENTRAL AMERICA
 Caribbean Drydock (Cuba)
 Ciramar, Dom. Rep.
 Caribbean Dockyard (Trinidad & Tobago)
SOUTH AMERICA
 SIMA, Callao (PERU)
 Cotecmar, Mamonal (Colombia)
 Tsakos Industrias Navales (Uruguay)

SPECIAL SERVICES:

Edicom Ou – worldwide (Thickness Measurement, Flying Squad),
 (afloat voyage repair/main engine overhaul),
 Marcontrol – worldwide (Port Repair, Voyage Repair and Electric Cargo Crane Automation),
 Marship (afloat repair with own berth/voyage repair in European ports/yards),
 STEP Consolidated – workshops in Brazil, Portugal and South Africa (Port Repair, Voyage Repair incl Flying Squads)
 Seagull Marine – SE Asia (Port Repair, Voyage Repair, specialised in PBCT propeller),
 Kwang-Youn-Gi Engineering Co. Ltd – Taiwan (Repair workshop with flying squad),
 Pasras - Balboa (port repair, specialised in ship's automation / main engine remote & safety)
 Bacviet, Haiphong (Taiwan) (port and voyage repair incl spare parts)
 Shanghai Marine Technology (China) (specialized in port repair, voyage repair)
 Hatchtec Marine Service, Shanghai (China) (specialized in hatch cover/deck crane/windless/winch/ro-ro/grab)
 General Shipping, Piraeus, workshop, tank treatment, blasting/painting specialist
 Kamji, all China, workshop, spare parts, agent
 Dimar-Tec, Singapore, fuel efficiency + monitoring systems
 Cliin Robotics, Denmark
 Seven Ocean, spare parts India
 Dai Hwa Engineering, Korea, workshop
 HMPs, Korea, retrofit, ship repair, eco-friendly conversion



GERMANIA SHIPYARD AGENCY GMBH



Schauenburgerstr. 35,
 20095 Hamburg, Germany
 Tel: +49 40 300 877 99
 Fax: +49 40 303 826 07
 Email: germania@shipyard-agency.de
 Web: www.shipyard-agency.com
 Contact:
 Christof Gross, Eliane Tietz, Oliver Kirmse, Kai Pahnke

SHIPYARDS
 NORTH AMERICA/CENTRAL AMERICA/CARIBBEAN:
 • Chantier Davie Canada Inc. (Canada)
 • Seaspan Vancouver Drydock (Canada)
 • Seaspan Victoria Shipyards Company Ltd. (Canada)
 • TNG Talleres Navales del Golfo (Mexico)
 SOUTH AMERICA:
 • SPI Astilleros S.A. (Argentina)
 FAR EAST:
 • DSIC Changxingdao Shipyard Co., Ltd. (Dalian)
 • Huarun Dadong Dockyard Co., Ltd. (China)
 • IMC Shipyard (Zhoushan) Co., Ltd.
 • PaxOcean Engineering Zhoushan Co. Ltd. (China)
 • PaxOcean Shipyard Pte. Ltd. (Singapore)
 • PaxOcean Asia (Pertama, Indonesia)
 • CSSC Qingdao Beihai Shipbuilding Co., Ltd.
 • Unithai Shipyard and Engineering Ltd (Thailand)
 • Yiu Lian Dockyards Limited (Hongkong)
 • Yiu Lian Dockyards (Shekou) Limited, China
 • Yiu Lian Dockyards (Weihai) Limited, China
 • Yiu Lian Dockyards (Zhoushan) Limited, China
PERSIAN GULF:
 • Drydocks World Dubai LLC (UAE)
MED/BLACK SEA:
 • Bulyard Shipbuilding Industry AD (Bulgaria)
 • Carell S.A. (Greece)
 • Chantier Naval de Marseille (France)
 • San Giorgio del Porto Genoa (Italy)
 • Sefine Shipyard (Turkey)
EUROPE ATLANTIC/BALTIC:
 • Astander (Spain)
 • Astican (Gran Canaria, Spain)
 • Balt Yard (Gdynia)
 • BREDO Dry Docks GmbH (Germany)
 • Blohm+Voss BV. & Co. KG (Germany)
 • Harland&Wolff (Belfast, UK)
 • Navikon SRY Ltd (Poland)
 • Oresund Drydocks (Sweden)

AFLOAT COMPANIES:

• Bludworth Marine (USA)
 • BMT Repairs (Spain)
 • Drydocks World Global Offshore Services (UAE)
 • DSK Co., Ltd (Korea)
 • HON Marine (Malaysia)
 • Longkong Marine Engineering Co., Ltd (China)
 • Oceantrans Marine Services Co. Ltd (China)
 • Offshore Inland Marine & Oilfield, LLC (USA)
 • On Site Alignment (Netherlands, UK, USA, Singapore)
 • MarineService Hirthals A.S. (Denmark)
 • Metalock (Brasil)
 • ROG Rotterdam Offshore Group (Netherlands)
 • Trident BV. (Netherlands)
 • Trident (Italia)
 • Trident (Malta)
 • Trident (Spain)
 • Trident (UAE)
 • UMA Marine Group (India)
SPARES AND EQUIPMENT:
 • Greentec Marine Engineering Co. Ltd
 • IHB ShipDesign AD
 • LAB S.A.
 • SunRui Marine Environment Engineering (China)
 • Senda Shipping Engineering & Service Ltd (China)
 • VICUS Desarrollos Tecnológicos S.L. (Spain)

Greece



T J GIARVIDIS MARINE SERVICES CO LTD



Georgada16, 145 61 Kifissia, Athens, Greece
 Tel: (0030) 211 10 42000,
 Fax: (0030) 210-4182 432
 Email: info@giaavidisgroup.gr
 Web: www.giaavidisgroup.gr
 Contact: Mr John Giavidis
 Mobile: (0030) 6936 201988
 Contact: Mr Nikolaos Giavidis
 Mobile: (0030) 6936 766165

SHIPYARDS AND SHIP REPAIRERS REPRESENTED

AFRICA
 NAMDOCK - Namibia Drydock & Ship Repair (Pty) Ltd. - Walvis Bay (Namibia)
 Dormac Marine & Offshore Engineering

AMERICAS
 ASTIBAL (Panama)
 Breakwater International (U.S.A.)
 Detyens Shipyard (U.S.A.)
 GSRJ - German Shiprepair Jamaica Ltd
 Offshore Inland (U.S.A.)
 Proios S.A. (Argentina)
 Talleres Industriales S.A. (Panama)
 Tandano Shipyard (Argentina)
 Vancouver Drydock Co. - SEASPAN GROUP (Canada)
 Vancouver Shipyards Co. Ltd. - SEASPAN GROUP (Canada)
 Victoria Shipyards Co. Ltd. - SEASPAN GROUP (Canada)

ASIA
 Chengxi Shipyard (China)
 Cosco Shipping Heavy Industry Group (China)
 Cosco Shipping Heavy Industry Dalian Shipyard
 Cosco Shipping Heavy Industry Guangdong Shipyard
 Cosco Shipping Heavy Industry Nantong Shipyard
 Cosco Shipping Heavy Industry Shanghai Shipyard
 Cosco Shipping Heavy Industry Zhoushan Shipyard
 Cosco Shipping Maritime Technology Dalian Co Ltd (China)
 Cosco Weihai Shipbuilding Marine Technology Co Ltd (China)
 CSSC Shanghai Marine Diesel Engine Research Institute - SMDERI (China)
 CUD Weihai Shipyard (China)
 Dalian Shipbuilding Industry Company (China)
 Fujian Huadong Shipyard (China)
 Guangzhou Weichong Shipyard (China)
 HAEIN (South Korea)
 Huarun Dadong Shipyard (China)
 IMC Shipyard Zhoushan (China)
 Kwang Youn Gi Engineering (Taiwan)
 Long Kong Marine Engineering (China)
 Orient Shipyard Co. Ltd. (South Korea)
 Pmax One Technologies Pte. Ltd. (Singapore)
 Qatar Shipyard Technology Solutions (ex. Nakilat Keppel Offshore & Marine Shipyard - Keppel Group) (Qatar)
 Qingdao Beihai Shipyard (China)
 Ruitai Nantong Shipyard (China)
 Sasebo Heavy Industries Co. Ltd. (Japan)
 Seatrium Repairs & Upgrades Pte. Ltd (Singapore)
 Seatrium Batangas Shipyard (Philippines)
 Seatrium Subic Shipyard & Engineering (Philippines)
 Shanhaiguan Shipyard (China)
 Tru - Marine Dubai (U.A.E.)
 Tru - Marine Pte. Ltd. (Singapore)
 Tru - Marine Shanghai, Tianjin, Guangdong, Zhoushan (China)
 Yui Lian Dockyards - Hong Kong
 Yui Lian Dockyards - Weihai
 Yui Lian Dockyards - Zhoushan
 Yuilian Dockyards Shekou (China)
 Zhoushan Changhong Shipyard (China)
 Zhoushan Huafeng Shipyard (China)
 Zhoushan Paxocean Shipyard (China)
 Zhoushan Xinya Shipyard (China)

EUROPE
 Astilleros Canarias S.A. (Astican Shipyard) (Spain)
 Astilleros De Santandr S.A. (Astander Shipyard) (Spain)
 Bulyard Shipyard (Bulgaria)
 Desan Shipyard (Turkey)
 Fincantieri Cantieri Navali Italiani S.P.A. Group (Italy)
 Fincantieri Palermo Shipyard (Italy)
 Fincantieri Trieste Shipyard (Italy)
 Fincantieri Muggiano Shipyard (Italy)
 Gemak Shipyard (Turkey)
 Remontowa Ship Repair Yard (Poland)
 Rotterdam Shiprepair RSR (The Netherlands)
 T.K. Tuzla Shipyard (Turkey)
 Tersan Shipyard (Turkey)
 Tru - Marine Rotterdam (The Netherlands)

OCEANIA
 Babcock Fitzroy Ltd. (New Zealand)
 Varley Group (Australia)



RESOLUTE MARITIME SERVICES INC.

233, Syngrou Avenue,
 171 21 N. Smyrni,
 Athens - Greece
 Tel: +30 211 182 9000
 +30 211 182 8991
 Fax: +30 211 182 9002
 Email: main@resolute.gr
 Web: www.resolute.gr

Contact: Alex & Andreas Scaramangas, Nikos Pappas & Dimitris Voronos

EXCLUSIVE REPRESENTATIONS

ASRY (Bahrain)
 Lisnave (Portugal)
 Dakarnave (Senegal)
 Navalrocha (Portugal)
 HSD Marine and Shiprepair (Singapore)
 Maindeck (Technical project management software)

DEDICATED CO-OPERATIONS

ART Shipyard (Turkey)
 Gemak Group (Turkey)
 Odessos Shiprepair Yard (Bulgaria)
 Ciramar Shipyard (Dominican Republic)
 CL Marine - Caribbean Dockyard (Trinidad and Tobago)
 Austal USA West Campus (Mobile, Alabama, US Gulf)
 Offshore Inland Marine & Oilfield Services, Inc. (Mobile, Alabama, US Gulf)
 Gulf Marine Repair (Tampa, Florida, US Gulf)
 CSSC Qingdao Beihai Shipbuilding Co., LTD. (China)
 Fujian Huadong Shipyard (China)
 Ruitai Nantong Shipyard Co., LTD. (China)
 Zhoushan Huafeng Shipyard Co., LTD. (China)



WSR SERVICES LTD

77 Vasileos Pavlou, 1st Floor 16673, Voula, Greece
 Tel: +3021 0428 2552
 Email: mail.gr@umarwsr.com
 Web: www.umarwsr.com

SHIPYARDS

ASL Marine Holdings Ltd-Batam, Indonesia
 Bredo Dry Docks - Bremerhaven, Germany
 Caribbean Dockyard Engineering Services Ltd (COESL) - Trinidad & Tobago
 Chengxi Shipyard Co. Ltd - Shanghai, China
 Colombo Dockyard Ltd - Colombo, Sri Lanka
 Detyens Shipyards - Charleston, South Carolina, USA
 Dormac Marine & Engineering - Capetown/Durban, South Africa
 EDR Antwerp Shipyard - Antwerp, Belgium
 Fayard A/S - Munkebo, Denmark
 Gemak Shipyard - Tuzla, Turkey
 Guangzhou Wenchong Shipyard - Guangzhou, South China
 Harland and Wolff Heavy Industries - Belfast, N. Ireland
 Hengli Heavy Industry - Dalian, North China
 Huarun Dadong Dockyard (HRDD) - Shanghai, China
 International Ship Repair - Tampa, Florida, USA
 Lloyd Werft Bremerhaven AG - Bremerhaven, Germany
 MTG Dolphin - Varna, Bulgaria
 Netaman Repair Group - Tallinn, Estonia
 Ozata Shipyard - Yalova, Turkey
 Papua New Guinea Dockyard - Papua New Guinea
 IMC Shipyard (Zhoushan) - Zhoushan, China
 Nanyang Star Group - Zhoushan, China
 Shanhaiguan Shipbuilding Industry Co., Ltd - Hebei, North China

UNDERWATER AND AFLOAT

Argus Marine Services - Columbia
 Avalontec Engineering - Singapore
 Boilerman - China, Singapore, Kobe
 Zener Maritime - India, Singapore, Rotterdam, Houston, Dubai

ROG Ship Repair - Rotterdam
 Atlantis Marine Services LLC - Fujairah, UAE
 I-Dive Services, Singapore
 Underwater Contractors - Spain
 Resolve Marine Services - Gibraltar
 Reprosul - Las Palmas
 RIMS BV
 On site alignment
 LDM Stations in Singapore and Europe



SEADOCK MARINE AGENCIES LTD

Akti Miaouli & Skouze 1,
 Piraeus 185 35, Greece
 Tel: +30 21 0429 2251
 Mobile: +30 6947 56 46 36
 Email: piraeus@seadockmarine.com
 Web: www.seadockmarine.com
 Contact: George Lyras

COMPANIES REPRESENTED

Emden Dockyard (Emden, Germany)
 Desan Shipyard (Tuzla, Turkey)
 Ozata Shipyard (Yalova, Turkey)
 Tersan Shipyard (Tuzla - Yalova, Turkey)
 Ruitai Shipyard (Nantong, China)
 IMC YY (Zhoushan, China)
 Stonestar Shipyard (Weihai, China)
 CUD Shipyard (Weihai, China)
 Weihai Huadong (Weihai, China)
 Qingdao Beihai Shipyard (Qingdao, China)
 HRDD Shipyard (Shanghai, China)
 Zhoushan Huafeng Shipyard (Zhoushan, China)
 Xinya Shipyard (Zhoushan, China)
 Longshan Shipyard (Zhoushan, China)
 Yui Lian Dockyards (Shekou) (Mazhou Islands, China)
 Fujian Huadong Shipyard (Fuzhou, China)
 Hankook Made (Mokpo, Korea)
 TurboTechnik GmbH & Co. KG (Wilhelmshaven, Germany)
 Dynamic Co (Piraeus, Greece)
 Bulyard, Varna (Bulgaria)
 Astilleros Cernaual (Algeciras, Spain)

Italy



BANCHERO COSTA & C.

Agenzia Marittima S.p.A.,
 2 Via Pammatone,
 16121 Genoa, Italy
 Tel: +39 010 5631 626/629/634
 Fax: +39 010 5631 602
 Email: shipyard@bcagy.it
 Web: www.bancosta.it
 Contact: Fabio Bertolini
 Mobile: +39 335 8078217
 Contact: Daniele Perotti
 Mobile: +39 335 7366801
 Contact: Giovanna Ximone
 Mobile: +39 335 7366802

COMPANIES REPRESENTED

Asaba shipyard (Equatorial Guinea)
 Astilleros Cernaual, Algeciras (Spain)
 Astilleros Mario Lopez, Malaga (Spain)
 Chengxi Shipyard (China)
 CM Korea Ltd
 CMR Tunisie (Tunisia)
 Colombo Dockyard (Sri Lanka)
 Cromwell & C. (Argentina)
 Crug-Versitec (marine sealing solutions - Cyprus)
 Damen Shiprepair & Conversion
 • Damen Shiprepair Amsterdam (The Netherlands)
 • Damen Shiprepair Oranjewerf, Amsterdam (The Netherlands)
 • Damen Shiprepair Brest (France)
 • Damen Shipyards Den Helder (The Netherlands)

• Damen Shiprepair Dunkerque (France)
 • Damen Shiprepair Harlingen (The Netherlands)
 • Damen Oskarshammsvarvet (Sweden)
 • Damen Shiprepair Van Brink Rotterdam (The Netherlands)
 • Damen Shiprepair Rotterdam (The Netherlands)
 • Damen Shiprepair Vlissingen (The Netherlands)
 • Damen Shipyards Sharjah-Albwardy Marine Engineering (UAE)
 • Damen Curacao shipyard
 • Damen Mangalia (former Daewoo Mangalia)
 • Damen Verolme (former Keppel Verolme) DIANCA Astilleros (Venezuela)
 EST Engineering Ship Technology (Singapore)
 Gemak Shipyard (Turkey)
 General Naval Control (Italy)
 General Shipping S.A (Greece)
 Guangzhou Dengtai Shipyard (China)
 Hyundai Mipo Dockyard (South Korea)
 Hyundai Vinasin Shipyard (Vietnam)
 Ibercisa (Spanish winches and deck machinery producer)
 Komax-Korean Maritime Repairs Service (South Korea)
 Malaysia Marine & Heavy Engineering (Malaysia)
 MSR Gryfia Shiprepair Yard (Poland)
 Paxocean Batam
 Paxocean Singapore
 Pregol Shiprepair Yard - Kaliningrad (Russian Federation)
 Promar Uab (propulsion and sealing services - Lithuania)
 Qingdao Beihai Shipyard (China)
 Riga Shipyard (Latvia)
 Sasebo Heavy Industries (Japan)
 Shanghai Shipyard (China)
 Sociber (Chile)
 SYM (Barcelona, Spain - Santo Domingo, Dominican Republic)
 ST Marine
 Underwater Shipcare, Singapore.
 Zhoushan Xinya Shipyard (China)

Italy / Monaco / Switzerland



CAMBIASO RISSO SERVICES SAM

Gildo Pastor Center, 7 Rue du Gabian,
 MC 98000, Monaco
 Switchboard: + 377 98801360
 Fax: + 377 97987848
 Email: tech@cariservice.com
 Web: www.cambiasorisso-service.com
 Contact: Massimiliano (Max) Iguera
 Direct Line: +377 98 801361
 Mobile: +33 640 623327
 Private email: max@cariservice.com

Contact: Giovanni Palumbo
 Direct Line: + 377 98801362
 Mobile: +33 640616602
 Contact: Mr Enrico Pittaluga
 Direct Line: +37798801363
 Mobile: +33640623184

COMPANIES REPRESENTED

Alabama Shipyard - Mobile (USA)
 ASMAR, Chile
 China Shipbuilding Corporation (Taiwan)
 • Kaohsiung Shipyard
 • Keelung Shipyard
 Cosco Shipping Heavy Industry
 • Cosco Dalian Shipyard
 • Cosco Guangdong Shipyard
 • Cosco Nantong Shipyard
 • Cosco Shanghai Shipyard
 • Cosco Zhoushan Shipyard
 • Cosco Qidong Offshore
 • Cosco Shipping Ppa, Greece
 • Nacks
 • Dacks
 CUD Weihai (China)
 Dakarnave (Senegal)
 Drydock World Dubai
 Elgin Brown & Hamer (South Africa)
 Grand Bahama Shipyard (Bahamas)
 Guangzhou Wenchong Dockyard (China)
 Gulf Copper (Port Arthur / Galveston / Corpus Christi - USA)

IMC – Yy Zhoushan (Zhoushan, China),
 Lisnave Estaleiros Navais SA (Portugal)
 Namibia Drydock
 Odessos Shiprepair Yard (Bulgaria)
 ONEX Elefsis Shipyards SA, Greece
 ONEX Neorion Shipyards SA, Greece
 Orient Shipyard (South Korea)
 PaxOcean Batam
 PaxOcean Singapore
 Qingdao Beihai Shipyard (China)
 Remontowa Shiprepair Yard (Poland)
 Renave (Brasil)
 Santierul Naval Costanta (Romania)
 Scamp Network Ltd (Gibraltar)
 Smit International (Rotterdam)
 Sefine Shipyard (Turkey)
 Tersan Shipyard (Turkey)
 Tsakos Industrias Navales (Montevideo, Uruguay)
 Tuzla Shipyard (Turkey)
 Unithai Shipyard & Engineering (Thailand)
 Western India Shipyard (India)



VICTORIA MARITIME SERVICES



7 Avenue des Papalins, MC 98000, Monaco
 Tel: +377 99995160
 Email: shiprepair@victoriamaritime.com
 Web: www.victoriamaritime.com

Contact: Luca Spinelli-Donati,
 Julia Sandmann, Carlo Spinelli-Donati,

SHIPYARDS REPRESENTED

- Asry of Bahrain
 Alimia Group:
 • Astander of Santander, Spain
 • Astibal of Balboa, Panama
 • Astican of Las Palmas De Gran Canarias, Spain
 Besiktas Group:
 • Art Shipyard of Tuzla, Turkey
 • Besiktas Shipyard of Yalova, Turkey
 • Park Shipyard of Yalova, Turkey
 Blrt Group:
 • Tallinn Shipyard of Tallinn, Estonia
 • Turku Repair Yard of Naantali, Finland
 • Western Shipyard of Klaipeda, Lithuania
 Carell of Piraeus, Greece
 Changhong International Shipyard of Zhoushan, China
 Chantier Naval De Marseille of Marseille, France
 Dormac of Durban and Cape Town, South Africa
 Ds Ship / Yeosu Ocean of Ulsan, Korea
 Edr Antwerp Shipyard of Antwerp, Belgium
 Fujian Huadong Shipyard of Fuzhou-Fujian, China
 Huarun Dadong Dockyard of Shanghai, China
 International Ship Repair & Marine Services of Tampa, Usa
 Multimarine Services of Limassol, Cyprus
 Oresund Drydocks of Landskrona, Sweden
 San Giorgio Del Porto of Genoa, Italy;
 Seatiurim:
 • Admiralty Yard of Singapore
 • Tuas Yard of Singapore
 • Tuas Boulevard Yard of Singapore
 • Benoy Yard of Singapore
 • Pioneer Yard of Singapore
 • Estaleiro Jurong Aracruz of Aracruz, Brazil
 Shanhaiguan Shipyard of Qinhuangdao, China
 Talleres Navales Del Golfo de Veracruz, Mexico
 Tandanor of Buenos Aires, Argentina
 Xinya Shipyard of Zhoushan, China
 Yiu Lian Dockyards of Hong Kong

MARINE SERVICE COMPANIES REPRESENTED

- Elettrotek Kabel of Bagnolo in Piano, Italy (special electrical cables producer)
 FTTM of Napoli, Italy (agents of Headway Technology)
 Harris Pye Group of Barry, UK (project management, mechanical and voyage repairs)
 Nextcorr of London, UK (marine growth prevention

and corrosion protection systems)
 PBM of Rijeka, Croatia (mechanical repairs)
 Polyflake of Miami, USA (high-performance, long-term anti corrosion protection)
 SES Marine Services of Singapore (voyage and afloat repairs)
 Turbo-Technik Repair Yard of Wilhelmshaven, Germany (mechanical repairs)

Lithuania, Latvia, Estonia, Poland, Russia, Ukraine



ORCA MARINE UAB



Silutes plentas 95D, LT-95112
 Klaipeda, Lithuania
 Tel: +370 46 246430
 Mobile: +370 650 40900
 Email: info@orca-marine.eu
 Web: www.orca-marine.eu
 Contact: Viktoras Cernusevicius

SHIPYARDS

- Asaba Shipyard (Malabo, Equatorial Guinea);
 Asmar Shipyard (Chile);
 Brodotrogir D.D. Shipyard Trogir (Croatia);
 Carena (Abidjan, Ivory Coast);
 Chantier Naval De Marseille (France);
 Colombo Dockyards (Sri, Lanka);
 Cosco Shipyards Group:
 • Cosco Dalian (China);
 • Cosco Nantong (China);
 • Cosco Shanghai (China);
 • Cosco Zhoushan (China);
 • Cosco Guangdong (China);
 • Cosco Lyanungang (China);
 Davie (Quebec, Canada);
 Detyens Shipyard (N. Charlestown, Usa);
 Dong Sung Engineering & Shiprepair (S.Korea);
 Damen Shiprepair Group:
 • Damen Shiprepair Dunkerque (France);
 • Damen Shiprepair Oranjewerf Amsterdam (Netherlands);
 • Damen Shiprepair Brest (France);
 • Damen Shiprepair Den Helder (Netherlands);
 • Damen Shiprepair & Conversion Rotterdam (Netherlands);
 • Damen Shiprepair Vlissingen (Netherlands);
 • Damen Shiprepair Amsterdam (Netherlands);
 • Damen Shiprepair Harlingen (Netherlands);
 • Damen Oskarshamnsvärvet (Sweden);
 • Damen Shiprepair Van Brink Rotterdam (Netherlands);
 • Damen Shiprepair Curacao (Curacao, Dutch Antilles).
 Enavi Reparos Navais (Rio De Janeiro, Brazil);
 Fama Group (Cyprus);
 Gibdock (Gibraltar);
 Harland & Wolff (Belfast, Uk);
 Mmhe Shipyard (Malaysia);
 Astibal (Panama);
 Namdock (Walvis Bay, Namibia)
 Narp Shiprepair:
 • Kiran/Erkal Tuzla (Tuzla, Turkey);
 • Hat-San Shipyard (Yalova, Turkey);
 • Tersan Shipyard (Yalova, Turkey);
 • Sefine Shipyard (Yalova, Turkey);
 • Hicri Ercili Shipyard (Yalova, Turkey);
 • Gisan Shipyard (Tuzla, Turkey);
 Oman Drydock (Oman);
 Sima (Peru);
 San Giorgio Del Porto (Genova, Italy);
 Tandanor (Buenos Aires, Argentina);
 Tsakos Industrias Navales (Montevideo, Uruguay);
 Zamakona Yards:
 • Zamakona Pasaia (Spain);
 • Zamakona Las Palmas (Canary Isl., Spain);
MARINE SERVICE COMPANIES
 Argo Navis (Greece) - Marine Consulting & Engineering (bwt, Soxnox);
 Chinaport Cleanseas - De-Slopping, Cleaning (China);
 Dgs Industrial & Naval (Brazil) - Afloat Repairs;
 Mechadinamik - Mechanical Services, Turkey
 One Net - Satelites Communications, Bridge Equip-

ment Service;
 One Tech - Technical Service;
 Sym - Afloat Repairs & Marine Services

The Netherlands



AYS SHIPREPAIR



Oranjekanaal ZZ 14, 7853TC Wezuperbrug,
 The Netherlands
 Mobile: +31 6 47 952 452
 Telephone: +31 85 0160 635
 Email: hilka@aysshiprepair.nl
 Web: www.aysshiprepair.nl

SHIPYARDS

- EUROPE
 Bulyard (Bulgaria)
 Bredo Drydocks (Germany)
 Gibdock (Gibraltar)
 Platinum (Turkey)
 NORTH AMERICA – CARIBIC
 Canada East - Davie (Quebec)
 Canada West - Seaspan (Vancouver)
 Seaspan (Victoria)
 US EAST COAST
 Detyens
 German Ship Repair Jamaica Ltd
 PERSIAN GULF
 Qatar Shipyard Technology Solutions
 AFRICA
 Namibia
 NAMDOCK (Walvis bay)
 SOUTH AFRICA
 Dormac (Capetown)
 Dormac (Durban)
 Dormac(Saldanha)
 ASIA
 Korea-Orient Shipyard (Busan)
 INDONESIA: ASL Marine(Batam)
 AUSTRALIA
 Thales (NS Wales)
 CHINA
 DSIC Changxingdao Shipyard (Dalian)
 Yiu Lian Dockyards (Hong Kong)
 Yiu Lian Dockyards(Shekou)
 Yiu Lian Dockyards(Zhoushan)
 Qingdao Beihai (Qingdao)
 Zhoushan Changhong International Shipyard Co., Ltd
 Zhoushan Putuo Changhong Shipyard Co., Ltd
 Zhoushan CIMC Changhong Shipyard Co., Ltd
SHIP REPAIR SERVICES
 BMT (Spain)
 Greentec Marine
 Haien Enc
 Rotterdam Ship Repair (Netherlands)
 German Ship Repair (Germany)
 Offshore Inland (US /GoM)
 Bludworth Marine (Houston)
 Unity Marine Services (Panama)
 Mapamar (Brasil)
 Brightsun(Singapore)
 Trident divers (Worldwide)



ESMA MARINE AGENCIES B.V.

Kuiperbergweg 35, 1101 AE
 Amsterdam, The Netherlands
 Tel: +31 20 3121350
 Email: shiprepair@esma.nl
 Mobile: +31 6 51 408 082
 Web: www.esma.nl
 Contact: Cees Onink (commercial manager)

Direct: +31 6 22 790 463
 Mobile: +31 6 22 790 463
 Contact: Jeroen Goedvree (technical manager)
 Direct: +31 6 29 409 141

COMPANIES EXCLUSIVELY REPRESENTED EUROPE -

- Kuzeystar (Tuzla/Istanbul, Turkey)
 Lisnave (Setubal, Portugal)
 Soby Vaerft (Soby Denmark)
 West Sea Viana Shipyard (Viana do Castelo, Portugal)
MIDDLE EAST -
 Drydocks World (Dubai, UAE)
 Drydocks World Global Offshore Services (DMC Dubai Maritime City, Shiplift)
FAR EAST -
 Colombo Dockyards (Colombo, Sri Lanka)
 PaxOcean (Asia)
 PaxOcean (Singapore)
 PaxOcean Pertama (Batam, Indonesia)
 PaxOcean Graha (Batam, Indonesia)
 PaxOcean Nanindah (Batam, Indonesia)
CHINA -
 Cosco Shipyard Group
 Cosco Dalian Shipyard (Dalian)
 Cosco Nantong Shipyard (Nantong)
 Cosco Qidong Shipyard (Qidong)
 Cosco Shanghai Shipyard (Qidong)
 Cosco Zhoushan Shipyard (Zhoushan)
 Cosco Guangdong Shipyard (Guangdong)
 PaxOcean (Asia)
 PaxOcean (Zhoushan)
WEST AFRICA -
 Dakarnave (Dakar, Senegal)



AIMSS V.O.F

Snellenshof 51, 4811LN Breda, The Netherlands
 Tel: +31 76 737 0002
 Email: sales@aimss.nl
 Web: aimss.nl
 Contacts: Sami Golestanian
 Email: sg@aimss.nl | Mobile: +31 6 28 96 38 48
 Onno Kramer
 Email: ok@aimss.nl | Mobile: +31 6 27 28 90 98

SHIPYARDS

- A&P Group (UK)
 - ASL (Indonesia)
 - ASMAR (Chile)
 - ASYAD Drydock (Oman)
 - CNDM (France)
 - NASCO Group (China)
 - NOSCO (Vietnam)
 - SAS (South Africa)
 - SGDP (Italy)
 - TERSAN (Turkiye)
 - TNG (Mexico)
 - UNITHAI (Thailand)
- MARINE SERVICES**
- CROSSCOMAR (Spain), Afloat repair, Construction works, Underwater Services & Voyage Repairs
 - DIAMOND SHIP (Taiwan), Store Supply
 - GENERAL SHIPPING (Greece), Tank Coating Specialists, Docking Services & Turnkey Projects
 - HAI HA M&S (Vietnam), Afloat repair, Construction works, Underwater Services & Voyage Repairs
 - JASON MARINE ELECTRONICS (Singapore & Spain) Supply & Service of Navigation, Communication & Automation Equipment
 - PBM (Croatia), Governors & ME Services, Woodward Parts & Services
 - PMS (Panama), Afloat repair, Construction works, Underwater Services & Voyage Repairs
 - RIDING TEAM, Supply of Qualified Welders, Fitters, Technicians, Electricians etc.
 - SINGATAC (Singapore), Afloat repair, Construction, Underwater Services & Voyage Repairs
 - WINKONG MARINE (China), Afloat, Underwater & Voyage Repairs
 - YARA MARINE TECHNOLOGIES (Norway), Fuel optimisation, Scrubbers
 - ZEBEC MARINE (India), Design, Engineering & Consulting Solution

Norway



BSA SHIPPING AGENCIES ANS



Akershusstranda 15, skur 35,
0150 Oslo, Norway
Contact:
Mr. Thord Peter Mossberg
Tel: +4723085000
Mobile: +4792012755
Email: peter@bsaship.com
Web: www.bsaship.com

SHIPYARDS

Dutch Offshore (The Netherlands)
ROG Ship Repair (The Netherlands)
Brodogradiliste d.o.o Shipyard LP (Croatia)
Falkvarv, (Sweden)
Cernalva Group Algeciras (Spain)
Hidramar S.L (Canary Islands)
General Shipping S. A (Greece)
TK Tuzla Shipyard (Turkey)
Sandock Austral Shipyards, (South Africa)
Qatar Shipyard Technology Solutions (Qatar)
Unithai Shipyard & Engineering Ltd (Thailand)
Fujian Huadong Shipyard Ltd (China)
HuaRunDadong Dockyard Ltd HRDD (China)
CUD (Weihai) Shipyard (China)
Pax Ocean Shipyard Zhoushan (China)
First Suez Ltd - Suez Canal Transit and Shiprepair (Egypt)
Caribbean Drydock Company S.A CDC (Cuba)



JML SHIPYARD AGENCY

Falkevägen 3, 457 40 Fjällbacka,
Sweden
Contact:
Markus Larsson, Managing Director
Mobile: +46 702 20 37 43
Email: markus@jmlshipyardagency.com
Web: www.jmlshipyardagency.com

SHIPYARDS REPRESENTED

EUROPE

Lloyd Werft, Bremerhaven, Germany
MSR Gryfia Shipyard, Szczecin, Polen
Sefine Shipyard, Tuzla, Turkey
San Giorgio del Porto, Genoa, Italy
Chantier Naval de Marseille, France
EDR Shipyard, Antwerp, Belgium
ASIA

Drydocks World, Dubai
Chengxi Shipyard, Jiangyin, China
Zhoushan Xinya Shipyard, China
Changhong International Shipyard, Zhoushan, China
PaxOcean, Zhoushan, China
Wenchong Shipyard Guangzhou, China
Shan Hai Guan Shipyard, China
Qingdao Beihai Shipyard, China
DSIC Marine Services, Dalian, China
PaxOcean, Singapore
PaxOcean Pertamina, Indonesia
PaxOcean Nanindah, Indonesia
PaxOcean Graha, Indonesia
US, CANADA & CARIBBEAN
TNG, Veracruz, Mexico
Ciramar Shipyard, Dominican Republic
Chantier Davie, Quebec, Canada
German Ship Repair Jamaica
Afloat Repair/Services
Global Offshore Service, Dubai UAE
Offshore Inland, US Gulf/Mexico
Crosscomar, Algeciras
UMA Marine, India

Link Marine / Automation, UAE
MCU Coatings
Carell, Greece
AFLOAT REPAIR
Global Offshore Service, Dubai UAE
Offshore Inland, US Gulf/Mexico
Crosscomar, Algeciras
UMA Marine, India
Link Marine / Automation, UAE
MCU Coatings
Carell, Greece



ULRIK QVALE & PARTNERS AS



Hoffsvien 13,
0275 Oslo
Tel: +47 22511616
Email: post@uqp.no
Web: www.uqp.no

Contact:

Oivind Qvale or Anders Lindheim

SHIPYARDS REPRESENTED

EUROPE:

Bredo Drydocks (Germany)
Nauta Shipyard (Poland)
Lisnave (Portugal)
Gemak (Turkey)
AFRICA:
Dakarnave (Senegal)
Dormac Marine & Engineering (South Africa)

AMERICAS:

Asmar (Chile)
Grand Bahama Shipyard (Bahamas)
Renave Industrial Group (Brazil)
Seaspan Vancouver Shipyard (Canada)

ASIA:

Arab Shipbuilding and Repair Yard (ASRY)
CHI Dalian Shipyard (China)
CHI Guangzhou Shipyard (China)
COSCO Shipping Shipyard (NANTONG) CO Ltd (China)
CHI Shanghai Shipyard (China)
CHI Xidong (China)
CHI Zhoushan Shipyard (China)
Japan Marine United Corp (Japan)

AFLOAT REPAIRS

Rotterdam Ship Repair (Netherlands)
Eerland Shiprepair (Netherlands)
HSD Marine (Singapore)
Marval (Chile)

Singapore



WSR SERVICES LTD



10 Eunos Road 8, #13-06,
Singapore Post Centre, S408600
Tel: +65 315 81050
Email: mail.sg@umarwsr.com
Web: www.umarwsr.com
SHIPYARDS
ASL Marine Holdings Ltd-Batam, Indonesia
Caribbean Dockyard Engineering Services Ltd (CDESL) - Trinidad & Tobago
Chengxi Shipyard Co. Ltd - Shanghai, China
Ciramar Shipyards - Dominican Republic
Colombo Dockyard Ltd - Colombo, Sri Lanka
CUD (Weihai) Shipyard - Shandong, North China
Detyens Shipyards - Charleston, South Carolina, USA

Dormac Marine & Engineering - Capetown/Durban, South Africa
EDR Antwerp Shipyard - Antwerp, Belgium
Fayard A/S - Munkebo, Denmark
Guangzhou Wenchong Shipyard - Guangzhou, South China
Huarun Dadong Dockyard (HRDD) - Shanghai, China
Hutchison Ports TNG (Talleres Navales del Golfo S.A.) - Veracruz, Mexico
International Ship Repair - Tampa, Florida, USA
Netaman Repair Group - Tallinn, Estonia
Onex Neorion Shipyard S.A - Syros Island Greece
IMC Shipyard (Zhoushan) - Zhoushan, China
Nanyang Star Group - Zhoushan, China
Shanhaiguan Shipbuilding Industry Co., Ltd - Hebei, North China

UNDERWATER AND AFLOAT

I-Dive Services, Singapore
LDM Stations in Singapore and Europe

Sweden



BSA SHIPPING AGENCIES ANS



Akershusstranda 15,
skur 35
0150 Oslo,
Norway
Contact:
Mr. Thord Peter Mossberg
Tel: +4723085000
Mobile: +4792012755
Email: peter@bsaship.com
Web: www.bsaship.com

SHIPYARDS

Brodogradiliste d.o.o Shipyard LP (Croatia)
Cernalva Group Algeciras (Spain)
Hidramar S.L (Canary Islands)
General Shipping S. A (Greece)
TK Tuzla Shipyard (Turkey)
Sandock Austral Shipyards, (South Africa)
Qatar Shipyard Technology Solutions (Qatar)
Unithai Shipyard & Engineering Ltd (Thailand)
Fujian Huadong Shipyard Ltd (China)
HuaRunDadong Dockyard Ltd HRDD (China)
CUD (Weihai) Shipyard (China)
Pax Ocean Shipyard Zhoushan (China)
First Suez Ltd - Suez Canal Transit and Shiprepair (Egypt)
Caribbean Drydock Company S.A CDC (Cuba)



JML SHIPYARD AGENCY

Falkevägen 3,
457 40 Fjällbacka, Sweden
Contact: Markus Larsson, Managing Director
Mobile: +46 702 20 37 43
Email: markus@jmlshipyardagency.com
Web: www.jmlshipyardagency.com

SHIPYARDS REPRESENTED

EUROPE

Lloyd Werft, Bremerhaven, Germany
MSR Gryfia Shipyard, Szczecin, Polen
Sefine Shipyard, Tuzla, Turkey
San Giorgio del Porto, Genoa, Italy
Chantier Naval de Marseille, France
EDR Shipyard, Antwerp, Belgium
ASIA
Drydocks World, Dubai
Chengxi Shipyard, Jiangyin, China
Zhoushan Xinya Shipyard, China
Changhong International Shipyard, Zhoushan, China
PaxOcean, Zhoushan, China
Wenchong Shipyard Guangzhou, China

Shan Hai Guan Shipyard, China
Qingdao Beihai Shipyard, China
DSIC Marine Services, Dalian, China
PaxOcean, Singapore
PaxOcean Pertamina, Indonesia
PaxOcean Nanindah, Indonesia
PaxOcean Graha, Indonesia
US, CANADA & CARIBBEAN
TNG, Veracruz, Mexico
Ciramar Shipyard, Dominican Republic
Chantier Davie, Quebec, Canada
German Ship Repair Jamaica
AFLOAT REPAIR/SERVICES
Global Offshore Service, Dubai UAE
Offshore Inland, US Gulf/Mexico
Crosscomar, Algeciras
UMA Marine, India
Link Marine / Automation, UAE
MCU Coatings
Carell, Greece

Switzerland



ENCOMPASS MARINE LIMITED



26 Flour Square, Grimsby
NE Lincs, DN31 3LP
United Kingdom
Tel: +44 (0) 1472 245500
Fax: +44 (0) 1472 245511
Email: services@encompassmarine.com
Web: www.encompassmarine.com

Contacts: David Maitland, Jon Thompson

Diving & Marine: Alan Jagger, Danielle Roberts

SHIPYARDS REPRESENTED

ART (Tuzla, Turkey)
Asyad (Duqm, Oman)
Asaba Shipyard (Malabo, Equatorial Guinea)
Cammell Laird Shiprepairers (Merseyside, UK)
Colombo Dockyard (Colombo, Sri Lanka)
COSCO Shipping Heavy Industry, China
• CHI Dalian
• CHI Nantong
• CHI Shanghai
• CHI Zhoushan
• CHI Guangdong
CUD (Weihai) Shipyard Co., Ltd.
Detyens Shipyard (Charleston, USA)
EDR Antwerp Shipyard (Belgium)
Grand Bahama Shipyard (Freeport, Bahamas)
Guangzhou Wenchong Dockyard (Guangzhou, China)
Hidramar Shipyards (Canary Isles, Spain)
Malaysia Marine and Heavy Engineering (Pasir Gudang, Malaysia)
Namibia Drydock and Ship Repair (Walvis Bay, Namibia)
Navantia (Spain)

• Cadiz Shipyard (Cadiz)

• Cartagena Shipyard (Cartagena)

• Ferrol-Fene Shipyard (Ferrol)

• San Fernando Shipyard (San Fernando)

Orient Shipyards (Busan/ Gwangyang, Korea)

Shanhaiguan Shipyard (Qinhuangdao, China)

Zhoushan IMC-YongYue Shipyard (Zhoushan, China)

Zhoushan Xinya Shipyard (Zhoushan, China)

DIVING & MARINE SERVICE COMPANIES

REPRESENTED

Atlantis Marine Services (Fujairah, UAE)

Blay Marine Tech (Spain)

Hellenika (Bulgaria)

Irwin Marine

Komas (Korea)

Lagersmit

Link Instrumentation (UAE & Singapore)

Marine Technical Services (Poland)

Maritime Shipcleaning Rotterdam

NARP Ship Repair (Turkey)

PmaxOne Services (Singapore)

Rentong Marine (China)

Rotterdam Ship Repair

TruMaine Group (Rotterdam, Singapore, China, Dubai)
Underwater Shipcare (Singapore)
Underwater Contractors Spain (Spain)
Wortelboer
Zener Maritime (Rotterdam, Mumbai, Singapore)
Over 200 diving stations worldwide

Turkey



TURMAR MARINE SURVEY CONSULTANCY AND SHIPPING INC.

Ilonu Cad. Turaboglu sok. Hamdiye Yazgan
Is Merkezi No.4, Kat.3 Kozyatagi 34742 Istanbul, Turkey
Phone: +90 216 411 45 75
Fax: +90 216 302 50 87
Email: turmar@turmarmarine.com
Web: www.turmarmarine.com
Contact: Burc Canga, +90 533 266 31 00
Igor Sumchenko, +90 532 212 74 81

COMPANIES REPRESENTED

- Göltens
- DMI
- Optimarim
- Norwater
- AMI Heat Exchangers
- Dalian Cosco Rikky Ocean Engineering
- Zhejiang Energy Marine Environmental Technology
- Shipyards Represented:
- ART Shipyard – Turkey
- Astander Shipyard – Spain
- Astican Shipyard – Canary Islands
- Besiktas Shipyard – Turkey
- Chantier Naval De Marseille – France
- Cosco Shipyard Repair Group – China
- Heisco Shipyard – Kuwait
- Hyundai Mipo Dockyard Co. Ltd. – South Korea
- Hyundai Vinashin Shipyard – Vietnam
- MYO Shipyard – Turkey
- San Giorgio Del Porto – Italy
- Sefine Shipyard – Turkey
- Tersan Shipyard – Turkey
- Yardgem Shipyard – Turkey
- Shipyards Represented (China):
- COSCO Dalian Shipyard
- DSIC Marine Services
- Shanhaiguan Shipyard
- Xixiakou Shipyard
- Qingdao Beihai Shipyard
- COSCO Shanghai Shipyard
- Huarun Dadong Dockyard
- SUD Shipyard
- CHI Nantong Shipyard
- Nantong Ruitai Shipyard
- Chengxi shipyard (Jiangyin)
- Changhong International shipyard
- Longshan shipyard
- Zhejiang Eastern Shipyard (ZESCO)
- COSCO Zhoushan Shipyard
- Fujian Huadong shipyard
- You Lian Dockyards Shekou,
- Guangzhou Wenchong Dockyard
- COSCO Guangdong Shipyard
- CSSC Guangxi

U.A.E.



WSR SERVICES LTD



Sheikha Maryam Bint Rashid
Bin Saeed Al Maktoum Bld.,
P114 Baniyas Square, Dubai
T:+971 4338 8918

Email: mail.ae@umarwsr.com
Web: www.umarwsr.com

SHIPYARDS

- ASL Marine Holdings Ltd-Batam, Indonesia
- Caribbean Dockyard Engineering Services Ltd (CDESL) - Trinidad & Tobago
- Chengxi Shipyard Co. Ltd - Shanghai, China
- Ciramar Shipyards - Dominican Republic
- Colombo Dockyard Ltd – Colombo, Sri Lanka
- Detyens Shipyards - Charleston, South Carolina, USA
- Dormac Marine & Engineering - Capetown/Durban, South Africa
- EDR Antwerp Shipyard - Antwerp, Belgium
- Fayard A/S - Munkebo, Denmark
- Guangzhou Wenchong Shipyard – Guangzhou, South China
- Huarun Dadong Dockyard (HRDD) - Shanghai, China
- Hutchison Ports TNG (Talleres Navales del Golfo S.A.) – Veracruz, Mexico
- International Ship Repair - Tampa, Florida, USA
- Netaman Repair Group - Tallinn, Estonia
- Onex Neorion Shipyard S.A - Syros Island Greece
- IMC Shipyard (Zhoushan) – Zhoushan, China
- Nanyang Star Group – Zhoushan, China
- Shanhaiguan Shipbuilding Industry Co., Ltd – Hebei, North China

UNDERWATER AND AFOAT

- I-Dive Services, Singapore
- LDM Stations in Singapore and Europe

United Kingdom



AIMSS GROUP LTD

Unit 16, Princeton Mews
167 London Road
Kingston upon Thames KT2 6PT
United Kingdom
T +44 20 3488 5528
Email: sales@aimss.co.uk
Web: aimss-shiprepair.com

SHIPYARDS

- ASL (Indonesia)
- ASTANDER (Spain)
- ASTICAN (Las Palmas)
- GRFIA (Poland)
- NASCO Group (China)
- NOSCO (Viet Nam)
- REIMERSWAAL (The Netherlands)
- SNC (Romania)
- TERSAN (Türkiye)
- TNG (Mexico)
- UNITHAI (Thailand)

MARINE PRODUCTS & SERVICES

- AEGIR MARINE (The Netherlands)
- Stern Tube Solutions (Supply, Parts & Services)
- CROSSCOMAR (Spain)
- Afoat repair, Construction, Underwater Services & Voyage Repairs
- DAMEN SCHELDE MARINE SERVICES (The Netherlands)
- Supply & Overhaul of Engine Parts, T/C, Pumps, Pneumatics & Hydraulics
- DIAMOND SHIP (Taiwan)
- Store Supply
- GENERAL SHIPPING (Greece)
- Tank Coating Specialists, Docking Services & Turnkey Projects
- HAI HA M&S (Vietnam)
- Afoat repair, Construction works, Underwater Services & Voyage Repairs
- INGLASCO (The Netherlands)
- LSA - FFE Equipment & Inspections
- JASON MARINE ELECTRONICS (Singapore & Spain)
- Supply & Service of Navigation, Communication & Automation Equipment
- KET MARINE (The Netherlands)
- Supply & Service of Heat Exchangers, Separators & Control Units
- MME (The Netherlands)
- Supply of Anodes, Advanced NDT, Marine Surveys & Rope Access
- PBM (Croatia)
- Governors & ME Services, Woodward Parts & Services
- PMS (Panama)

- Afoat Repairs, Underwater Services & Voyage Repairs
- GLOBAL DRONE INSPECTION (The Netherlands)
- Inspection with Drones
- ROG (The Netherlands)
- Afoat Repairs, Habitat Works & Voyage Repairs
- SINGATAC (Singapore)
- Afoat repair, Construction works, Underwater Services & Voyage Repairs
- RIDING TEAMS (Romania & Bulgaria)
- Supply of Qualified Welders, Fitters, Technicians, Electricians etc.
- VIVAR (The Netherlands)
- Technical Store Supply (ARA Range)
- WINKONG MARINE (China)
- Afoat repair, Construction works, Underwater Services & Voyage Repairs
- YARA MARINE TECHNOLOGIES (Norway)
- Fuel optimisation, Scrubbers.
- ZEBEC MARINE (India)
- Design, Engineering & Consulting Solution



CALVEY MARINE LIMITED

Broomers Barn, Merrywood Lane,
Storrington, West Sussex RH20 3HD,
United Kingdom
Tel: +44 (0) 1903 748860
Fax: +44 (0) 1903 743390
Email: calvey@calveymarine.co.uk
Web: www.calveymarine.co.uk

Contact: Steven Black
Mobile: +44 (0) 7885 217869
Contact: Suzanne Black
Mobile: +44 (0) 7867 785957
Contact: Jessica Black
Mobile: +44 (0) 7917 726274

COMPANIES REPRESENTED

- AMI Exchangers (Hartlepool)
- Beihai Shipyard (Qingdao)
- Beihai Lifeboats (Qingdao)
- Brightsun Group (Singapore)
- Cassar Ship Repair (Malta)
- Chengxi Shipyard (Jiangyin)
- Chengxi Shipyard (Xinrong)
- Changxing Shipyard (Shanghai)
- CHI Shipyards (China)
- Ciramar Shipyard (Dominican Republic)
- Diesel Marine International (Worldwide)
- Drydocks World Dubai (UAE)
- Drydocks World Dubai Global Offshore Services (UAE)
- Fujian Shipyard – Huadong
- Guangzhou Wenchong Dockyard
- Greens Power (UK)
- JinHai Shipyard (Zhoushan) Co., Ltd. China
- King-Marine (Global based in China)
- Lisnave Shipyard (Portugal)
- Nauta Shiprepair (Gdynia, Poland)
- North East Ship Repair, (Boston)
- North East Ship Repair (Philadelphia)
- Offshore Inland Marine & Oilfield Services (Alabama, USA)
- Pan Asia Company Ltd, South Korea
- PaxOcean Graha (Indonesia)
- PaxOcean Nanindah (Indonesia)
- PaxOcean Offshore Zhuhai
- PaxOcean Pertama (Indonesia)
- PaxOcean Shipyard Zhoushan
- PaxOcean Singapore
- Professional Manpower Supply (Panama)
- Shanhaiguan Shipyard (North China)
- Seatec Repair Services – (Worldwide)
- Tersan Shipyard – (Tuzla, Yalova)
- UMC International - (Worldwide)
- Vancouver Shipyard - (Vancouver)
- Victoria Shipyard - (Victoria)
- Viktor Lenac Shipyard (Croatia)
- Worldwide Underwater Services
- Yiu Lian Dockyards (Hong Kong)
- Yiu Lian Dockyards (Shekou)
- Yiu Lian Dockyards, Zhoushan, China
- Young & Cunningham Valves (North Shield)



ENCOMPASS MARINE LIMITED



26 Flour Square, Grimsby,
NE Lincs, DN31 3LP, United Kingdom
Tel: +44 (0) 1472 245500

Email: services@encompassmarine.com
Web: www.encompassmarine.com

Contacts: David Maitland, Jon Thompson
Diving & Marine: Alan Jagger, Danielle Roberts

SHIPYARDS

- ART (Tuzla, Turkey)
- Asyad (Duqm, Oman)
- Asaba Shipyard (Malabo, Equatorial Guinea)
- Besiktas Shipyard (Yalova, Turkey)
- BLRT Group
- Tallinn Shipyard (Tallinn, Estonia)
- Turku Repair Yard (Turku, Finland)
- Western Shipyard (Klaipeda, Lithuania)
- Cammell Laird Shiprepairers (Merseyside, UK)
- Colombo Dockyard (Colombo, Sri Lanka)
- COSCO Shipping Heavy Industry, China

- CHI Dalian
- CHI Nantong
- CHI Shanghai
- CHI Zhoushan
- CHI Guangdong
- CUD (Weihai) Shipyard Co., Ltd.
- Detyens Shipyard (Charleston, USA)
- EDR Antwerp Shipyard (Belgium)
- Guangzhou Wenchong Dockyard (Guangzhou, China)
- Hidramar Shipyards (Canary Isles, Spain)
- ISR Repair & Marine Service (Tampa, USA)
- Malaysia Marine and Heavy Engineering (Pasir Gudang, Malaysia)
- Namibia Drydock and Ship Repair (Walvis Bay, Namibia)
- Orient Shipyards (Busan/ Gwangyang, Korea)
- Shanhaiguan Shipyard (Qinhuangdao, China)
- West Sea Viana Shipyard (Viana de Castelo, Portugal)
- Zhoushan IMC-YongYue Shipyard (Zhoushan, China)
- Zhoushan Xinya Shipyard (Zhoushan, China)

DIVING & MARINE SERVICE COMPANIES REPRESENTED

- Atlantis Marine Services (Fujairah, UAE)
- Blay Marine Tech (Spain)
- Hellenika (Bulgaria)
- Irwin Marine
- Komas (Korea)
- Keyser Technologies (Singapore)
- Lagersmit
- Link Instrumentation (UAE & Singapore)
- Marine Technical Services (Poland)
- Maritime Shipcleaning Rotterdam
- Metallock Brasil (Brasil)
- Metallock Engineering DE (Germany)
- NARP Ship Repair (Tuzla, Turkey)
- PmaxOne Services (Singapore)
- Rotterdam Ship Repair
- Talleres Industriales (Panama)
- Techcross BWMS (Korea)
- TruMaine Group (Rotterdam, Singapore, China, Dubai)
- Underwater Contractors Spain (Algeciras, Spain)
- Underwater Shipcare (Singapore)
- Wortelboer
- Zener Maritime (Rotterdam, Mumbai, Singapore)
- Over 200 diving stations worldwide



EMCS INTERNATIONAL LTD

(MLC2006 Approved/ISO9001:2015 Accredited)
Marion House, 9 Station Road
Port Erin, Isle of Man IM9 6AE
United Kingdom
Tel: +44 1624 833955

Group email: enquiries@emcs.co.im
 Web: www.emcs.co.im
 Contact: Richard George
 Mobile: +44 7624 492 716
 Contact: Amanda Green (North East UK Representative)
 Tel: +44 191 5160010
 Jamie Skillen (Diving Services)
 Tel: +44 7624 232916
 Cheryl Reeday (Superintendents Course)
 Email: superscourse@emcs.co.im

SERVICES PROVIDED
 Labour Supply for afloat ("riding teams")/shipyard/offshore repairs and maintenance
 All trades provided including welders, platers, mechanical/engine fitters, pipefitters, scaffolders, riggers, blaster/painters, tank cleaners, electricians plus chargehands and foremen.
 Consultancy Services/Vessel Inspections
 Diving Services Worldwide (Class and general vessel inspections, hull cleaning, underwater repairs, blanking etc)

COMPANIES REPRESENTED
 Electro Partners NV - Electrical/Electro Mechanical Workshop and Vessel Based Repairs (Antwerp/NW Europe)
 Web: www.electropartners.com

COURSE MANAGED
 Ship Superintendents' Training Course
 Web: www.emcs.co.im/superintendents-course/
SISTER COMPANY
 Ramsey Shipping Services: Above and below water-line repairs at Ramsey Shipyard, Isle of Man and Irish sea ship's agency services



L&R MIDLAND (UK) LTD.

Parkshot House, 5 Kew Road
 Richmond, TW9 2PR
 Tel: +44 (0) 20 3856 6520
 Email: ukenquiries@lrmidland.com
 Web: www.lrmidland.co.uk
 Contact: Russell Bell – Managing Director
 Direct: +44 (0) 20 3856 6523
 Mobile: +44 (0) 7887 473 123
 Email: rbell@lrmidland.com
 Contact: David Walker – Sales Manager
 Direct: +44 (0) 203 3856 6521
 Mobile: +44 (0) 7853 044 898
 Email: dwalker@lrmidland.com

SHIPYARDS REPRESENTED

- Seatrium (Singapore)
- Seatrium Admiralty Yard
- Seatrium Benoi Yard
- Seatrium Tuas Yard
- Seatrium Tuas Boulevard Yard
- Seatrium Subic Bay (Philippines)
- Asmar (Chile)
- Punta Arenas
- Talcahuano
- Valparaiso
- ASRY (Bahrain)
- Dakarnave – Dakar (Senegal)

Dormac (South Africa)
 • Cape Town
 • Durban
 • Walvis Bay
 Estalerio Jurong Aracruz – Aracruz (Brazil)
 Gemak – Tuzla (Turkey)
 Gibdock (Gibraltar)
 Grand Bahama Shipyard – Freeport (Bahamas)
 Mare Island Dry Dock – Vallejo, Ca (USA)
 NICO International (UAE)
 • Abu Dhabi
 • Dubai
 • Fujairah
 Oresund Drydocks – Landskrona (Sweden)



MARINE MARKETING INTERNATIONAL LTD



CABEKA House, 2 Grasscroft,
 Furzton, Milton Keynes,
 Bucks MK4 1AS, United Kingdom
 Tel: +44 1908 378822
 Mob: +44 7720074113
 Email: repair@marine.marketing
 Web: www.marine.marketing

Contact: Mike McMahon

COMPANIES REPRESENTED

- SHIPYARDS**
- Carell SA (Piraeus, Greece)
 - Carena (Abidjan, Ivory Coast)
 - Caridoc (Chaguaramas, Trinidad)
 - CMR Tunisia (Menzel Bourguiba, Tunisia)
 - Cotecmar (Cartagena, Columbia)
 - MTG Dolphin (Varna, Bulgaria)
 - Navalrocha (Lisbon, Portugal)
 - PGZ SW (Gdynia, Poland)
 - Sandock Austral Shipyard (Durban, South Africa)
 - TURKEY – With our partner OKT Ltd
 - Kuzey Star (Tusla)
 - Hat-San (Yalova)
 - Sefine Shipyard (Yalova)
 - TK TUZLA (Tusla)
 - Ozata Shipyard (Altinova)
 - CHINA – With our partner Shanghai Willing
 - CUD Weihai (Weihai)
 - Qingdao Beihai (Qingdao)
 - Chengxi Shipyard (Jiangyin)
 - Zhoushan Xinya (Zhoushan)
 - HRDD (Chongming, Shanghai)
 - Yiu Lian (Shekhou)

MARINE SERVICES

- BIO-UV Ballast Water Treatment (Lunel, France)
- Boilerman (Shanghai, Singapore, Dubai)
- Kwang Youn Gi Engineering (Kaohsiung, Taiwan)
- Marine Services & Shipping (Varna, Bulgaria)
- Sinco Automation (Singapore, Malaysia, Indonesia)
- Sunrui Environmental Engineering (Qingdao)



SEADOCK MARINE AGENCIES LTD

123 Minorities, London EC3N 1NT, United Kingdom
 Tel: +44 (0) 20 7680 4000
 Fax: +44 (0) 20 7553 0001
 Mobile: +44 (0) 77 10 327 004
 Email: sales@seadockmarine.com
 Web: www.seadockmarine.com

Contact: George D. Skinitis

COMPANIES REPRESENTED

- Emden Dockyard (Emden, Germany)
- Chalkis Shipyards (Chalkis, Greece)
- Metalships & Docks (Vigo, Spain)
- Ozata Shipyard (Yalova, Turkey)
- Tersan Shipyard (Tuzla - Yalova, Turkey)
- Navalink Sri, (Constanta, Romania)
- Ruitai Shipyard (Nantong, China)
- IMC YY Shipyard (Zhoushan, China)
- Stonestar Shipyard (Weihai, China)
- Hankook Made (Mokpo, Korea)
- TurboTechnik GmbH & Co. KG (Wilhelmshaven, Germany)
- Dynamic Co. (Piraeus, Greece)
- Bulyard (Varna, Bulgaria)
- Astilleros Cernaival (Algeciras, Spain)
- N-KOM (Qatar)

United States



L&R MIDLAND INC.

788 W Sam Houston Pkwy North, Suite 200
 Houston, TX 77024, USA
 Tel: +001 713 680 0909
 Fax: +001 713 680 9704

Email: shipyard@lrmidland.com

Web: www.lrmidland.com

Contact: Tom McQuilling,

Ryan Smith,

James McQuilling

SHIPYARDS REPRESENTED

- Seatrium (Singapore)
- Seatrium Admiralty Yard
- Seatrium Benoi Yard
- Seatrium Tuas Yard
- Seatrium Tuas Boulevard Yard
- Seatrium Subic Bay (Philippines)
- Damen Shiprepair & Conversion (Netherlands)
- Amsterdam
- Rotterdam
- Vlissingen
- Damen Shiprepair & Conversion (France)
- Dunkerque
- Brest
- Damen Shiprepair & Conversion (Curacao)
- Willemstad
- Dormac (South Africa)
- Cape Town

- Durban
- Walvis Bay
- Fincantieri (Italy)



VOGLER MARINE AGENCIES LLC

20 Bartles Corner Road, Flemington
 New Jersey 08822, USA
 Tel: +1-908-237-9500
 Fax: +1-908-237-9503

Email: shiprepair@vogler.net

Contact: Donald W Vogler

SHIPYARDS

- ASRY Arab Shipbuilding and Repair Yard (Bahrain)
- Saldanha Bay, Walvis Bay South Africa)
- SOCIBER (Chile)
- ASMAR Shipyards CHILE (Talcahuano, Punta Arenas and Valparaiso)

SHIPREPAIR COMPANIES EXCLUSIVELY REPRESENTED

- Metalock do Brasil Ltda. (Brazil)



SIMPLEX AMERICAS LLC



20 Bartles Corner Road, Flemington,
 New Jersey 08822, USA

Tel: +1-908-237-9099

Fax: +1-908-237-9503

Mobile: 247/365 +1-908-581-0900

Email: info@simplexamericas.com

Web: www.simplexamericas.com

Contact: Donald W Vogler – President

SERVICE, SPARES AND SALES

- Controllable and Fixed Pitch Propellers, Thrusters,
- Couplings, Gearbox, Z Drives
- Stern tube seals, Bearings and Bush Bearings
- Full Propulsion Packages and Total Shafting Solutions
- Hydraulic Coupling, Nuts and Bolts
- Shaft Alignment, In-Situ Machining, Chocking and Mounting Service
- Underwater Repairs and Service
- **FACTORY SERVICE, SPARES AND SALES**
- SKF Marine GmbH (SIMPLEX Compact & SIMPLAN)
- Jastram GmbH
- Nakashima Propeller Co. Ltd.
- Niigata Power Systems Co. Ltd.
- SKF Coupling Systems AB & Pilgrim
- Hoppe GmbH
- KUMERA Marine
- Turbulo Oily Water Separators

More marine energy support required

RENEWABLE POWER | The UK's Marine Energy Council (MEC), a trade association representing the country's tidal stream and wave energy sectors, has called on the new UK Government to ramp up support for these power sectors. Tides and waves, the MEC claims, have the potential to provide more than a third of the country's total electricity demand.

Highly predictable tides offer significant prospects and, according to the MEC, the UK has 'an unrivalled deployment pipeline'. The country is on course to have more than 100 MW of tidal stream capacity in its waters by 2028, it said. The projects also rely on more than 80% UK supply chain content, creating jobs in coastal communities and beyond.

On wave energy, the MEC warned that without a clear route to market and more support, the UK risks being left behind. Waves are the world's largest untapped energy resource, it said, and there are projects heading towards commercialisation in countries including Ireland, the US, Portugal, Israel, and China.

The MEC is calling for 2035 targets to be set for tides and waves – 1 GW and 300 MW respectively. It highlights the need for a faster consenting process which, it says, can currently take up to



Source: MEC

The UK has over 30 GW of untapped tidal stream and wave energy capacity, enough to provide over a third of its electricity demand

four years. And it is seeking more favourable investment criteria. These and other measures, it claims, could reduce the cost of tidal energy by as much as 80%, taking prices below those currently prevailing for nuclear power.

Research undertaken at the London School of Economics has shown that the UK is a specialised innovator of marine energy technologies but, in the absence of access to EU funding, the Government needs to ensure that the UK continues to innovate, attract investment, create jobs, and support economic growth.

PODSZUCK®

Marine and Offshore Doors – Made in Germany Established in 1919





**A-, B- and C-Class doors...
Only the best should be standard**

Hinged and sliding doors with and without glass

Meet us at SMM
Hall B7,
booth B7.128

Podszuck® GmbH
Klausdorfer Weg 163
24148 Kiel
Germany
Tel. +49 (0) 431-66 1110
Fax. +49 (0) 431-66 111 28
info@podszuck.eu

www.podszuck.eu

Two-session conference

OFFSHORE DIALOGUE | As established conference part of SMM, this year's Offshore Dialogue will once again welcome marine leading experts to discuss innovative offshore energy concepts as well as offshore resilience, which is critical for the sustainability of energy systems.

The Offshore Dialogue is divided into two sessions: Offshore Energy on Thursday, September 5th from 11.00 am – 12.00 pm, and Offshore Resilience on the same day from 02.00 pm to 03.00 pm. Both sessions will be held on the Open Stage in Hall B2 (first floor). The Offshore Energy Session will be chaired by Prof. Sören Ehlers, director of the DLR Institute for Maritime Energy Systems. Participants are Dieter Janecek, Coordinator for the Maritime Industry and Tourism at the German Federal Ministry for Economic Affairs and Climate Action; Torgeir Sterri, Offshore Class director at DNV; and Marco Klein, head of Ship Performance Department at the DLR Institute of Maritime Energy Systems.

The Offshore Resilience Session is moderated by Walter L. Kuehnlein, terra.blue executive for NRG & Tech. He will welcome Sebastian Unger, Ocean Commissioner of the German Federal Government and Director for Marine Environmental Protection at the Federal Ministry for the Environment, Nature Conservation, Nuclear Safety and Consumer Protection (BMUV); Patricia De Almeida, Director, Business Development, Global Offshore – Europe at ABS; and Erik Seidelmann, Application team lead at Current Scientific Corporation on stage.

After a short introduction, each session will start with three short flash talks of the panellists, followed by an open discussion, including the auditorium.

ENERGY at SEA

The European Offshore Wind Compendium | 2024



HYDROGEN

Consortium develops concept for European value chain

CONVERTER PLATFORMS

Meyer Werft takes important step for Germany's energy transition

FLOATING WIND

High potential as structures move further to sea



STRONG CONNECTIONS FOR A RENEWABLE FUTURE



Since 2005, the German Offshore Wind Energy Foundation has established itself as a non-partisan, supra-regional and cross-sector think tank as well as an independent communication platform for the entire offshore wind energy industry. Its overall purpose is to consolidate the role of offshore wind energy in the energy mix of the future in Germany and Europe. Guided by its scientific advisory board, the foundation promotes the expansion of offshore wind energy in the interests of environmental and climate protection. The foundation's board of trustees includes key federal and state ministries for offshore wind as well as operators, manufacturers, transmission system operators, suppliers, banks, and insurance companies.

Together, we forge strong connections for a renewable future!

WWW.OFFSHORE-STIFTUNG.DE



It's all in the mix

The renewable energy of the seas consists of many different sources that are abundant, natural and clean, like wind, waves and tides. When we talk about offshore energy, the first thing that comes to mind, however, is offshore wind, as the most mature segment.

The offshore wind industry has seen strong growth at all levels globally over the last ten years. Political stakeholders around the world are focussing on offshore wind for near-base load power generation.

Industrial companies are securing renewable offshore electricity with power purchase agreements in order to drive forward their decarbonisation. In research and in practice, the (future) contribution of offshore wind energy to the development of a hydrogen economy based on renewable energy is also an issue.

Global offshore wind capacity reached a total of 75 GW at the end of 2023. The Global Wind Energy Council's ten-year outlook shows that, with the right framework in place, the world could be on course to deploy 410 GW by 2033.

That means total offshore wind capacity may reach 485 GW by the end of 2033. While this is certainly the right pathway, it is only a fraction of likely energy demand. And there is certainly far more potential that has not been assessed or exploited so far.

Figures from the UN Panel on Climate Change, for example, estimate that some 29,500 terawatt-hours (TWh) of wave energy could be harnessed. For comparison: in 2023, total global energy consumption was an estimated 27,000 TWh.

And there is tidal power: the movement of water caused by the gravitational pull of the moon generates a reliable and constant form of energy. While there are pioneering projects already in progress, these are mostly prototypes and with no proper scalability as yet.

If we look at the surface area of the oceans (around 71% of the earth), there is clearly huge potential here. But with it still come a lot of hurdles. The expansion of the offshore wind energy, even though the most advanced of the three sources mentioned, still faces several challenges, among them an increase in component production costs, access to finance, interest rates, pressure on supply chains, port and shipping capacities, and installation technology.

However, from a commercial perspective, there are many opportunities for technology and financial structuring in all areas of the offshore energy arena. Systems need to be developed and produced, installation, commissioning and service vessels need to be designed and built with the latest technologies, and service



Kathrin Lau
Editor in Chief
Schiff&Hafen | Ship&Offshore

bases need to be developed in and around harbours.

Investment security is an important point in this respect. Of course, the world's growing population will require more and more energy and this must be available in a sustainable manner wherever possible. However, companies will not be able to pay in advance out of pure philanthropy and without financial security.

The right political framework, as mentioned above, combined with appropriate support, as is rightly demanded by port authorities in Germany, among others, will be of crucial importance here.

Content

Interview: "We need to think about the hydrogen economy from a European perspective and network even more closely"	78	High potential as structures move further to sea	84
Marine technology is crucial for the offshore wind industry	80	Denmark on the way to CCS infrastructure	86
Converter platforms made in Germany	82	Global projects still in their infancy	88

“We need to think about the hydrogen a European perspective and network

INTERVIEW A project consortium of more than 100 partners wants to produce one million tonnes of green hydrogen a year in the North Sea and transport it to land via pipeline. Ship&Offshore spoke to Robert Seehawer, managing director of the AquaVentus development organisation, about the strategy for offshore wind hydrogen production.

Mr Seehawer, with the AquaVentus development association, you have created a vision of producing green hydrogen directly in the North Sea from offshore wind power. What are your goals and where do you stand with this ambitious project?

Robert Seehawer: Our goal is to install around 10 GW of offshore wind generation capacity in the North Sea off Heligoland and use this at sea to produce green hydrogen by electrolysis and bring it ashore via pipeline. However, this project should not remain a vision – we want to make it a reality together with our 100 or so members and partners. Since it was founded three years ago, AquaVentus has therefore been initiating various projects for the ramp-up.

What concrete steps do you need to take now?

It is now a matter of putting together the existing pieces of the puzzle of the relevant technologies and proving in pilot projects and then in

everyday operation that the project works. An important milestone for this is the tendering process in the SEN-1 wind priority area in the German Bight, an area that the Federal Maritime and Hydrographic Agency will prepare in cooperation with the Federal Ministry for Economic Affairs and Climate Protection.

In a second step, our partners will realise the approximately 1,000 MW of capacity to be installed here as consortia with the AquaSector project, among others. On the way to the 10-GW vision of the AquaVentus initiative, we will be commissioning power plant-sized systems for the first time, generating up to 100,000 tonnes of green hydrogen and bringing it ashore via the AquaDuctus pipeline. The SEN-1 demonstration site will show that we can develop high-performance value chains based on offshore electrolysis.

Why is it advantageous to produce hydrogen at sea and bring it ashore by pipeline?

The DNV study “Specification of a European Offshore Hydrogen Backbone” emphasises the considerable advantages of an offshore hydrogen network in the North and Baltic Seas. This primarily concerns areas in the centre of the North Sea that are more than 100km from land and where customers can only be supplied cost-effectively via a pipeline. Our AquaDuctus project will be connected to the planned hydrogen core network in Germany and, thanks to its open access regulation, offers all operators of offshore electrolyzers the opportunity to bring hydrogen ashore. The pipeline is also to be extended to Norway, giving other North Sea neighbours the opportunity to import hydrogen. The gas transport network operators Gassco and Gascade signed a Letter of Intent for this in April 2024. Compared with a 2-GW submarine cable, we can build a pipeline that transports much more energy for the same cost.

Nevertheless, the entire project sounds very expensive. Is it possible to estimate the price at which hydrogen from offshore electrolysis will be available?

We will soon present a study that will show, on the basis of exemplary cost calculations, that we can expect a reasonable price for green offshore hydrogen in the medium term. This is because we need green offshore hydrogen, especially where it competes with fossil fuels such as coal and gas. With rising carbon dioxide prices, also due to the Emissions Trading System 2, the use of fossil fuels is likely to become even more expensive, making hydrogen a worthwhile alternative. I also see this as the most sustainable setup to get away from subsidies in the long term. We therefore want green hydrogen to be used “materially” as a molecule in order to save a lot of fossil carbon dioxide and protect the climate. On the supply side, we are making good regulatory progress. Nevertheless, we would like to see more support on the production side for “domestically” produced offshore hydrogen in order to develop the technology further.

How will a market for hydrogen produced offshore develop in the future?

We are still a long way from a market. As an economist, I see a market as a polypole, with many suppliers and consumers. We definitely won't see that for green hydrogen in the next few years. First of all, we need



Source for all images: AquaVentus

The hydrogen will be transported ashore via pipeline



economy from even more closely”

to build up electrolysis capacity onshore and offshore gradually, and import hydrogen to transform our energy landscape.

Where do you see the greatest demand for green offshore hydrogen?

Clearly in the industries that cannot be electrified and have significant carbon dioxide emissions – steel, chemicals, and the so-called basic materials industry. We need to make progress with offshore electrolysis in order to leverage the energy potential of one million tonnes of green hydrogen. But even with this amount, we will only be able to cover around 40% of the demand for green steel production. We therefore still need imports, because we also need hydrogen as a storable medium for peak-load power plants. In terms of the energy transition, we don't have many alternatives.

In the Netherlands, there is a similar project to AquaVentus, “PosHYdon”, although it is much smaller. The state has made a financial contribution here. Would you like to see something similar from the German Government?

I personally think that such a participation model would be expedient, especially for the pilot. In the Netherlands, the state has a minority shareholding and receives information and knowledge with which it can continue to provide targeted support. The more advanced and commercialised the projects are, the less government funding will be needed. However, a binding timetable is much more important. The Wind Sea Act stipulated auctions for offshore hydrogen production on SEN-1 for 2022, but these have not yet taken place. It is essential that we can plan sensibly. This is extremely important so that our members can prepare for the projects and the market ramp-up in a targeted manner.

What do you think should be on the agenda of the next EU Commission?

We need more development in the offshore electrolysis industry. This can only work if we think in European terms and network even more closely. This is already taking place with the North Sea summits and working meetings. Of course, this needs to be well coordinated. It would be desirable if we saw the hydrogen economy more



Robert Seehawer,
managing director,
AquaVentus

in a European context and included it as an essential pillar in the discussions.

Where do you see the project in five years' time?

In five years, we will be much further along, we will definitely have a pilot plant and we will have the AquaDuctus pipeline – at least close to completion – from Wilhelmshaven to the outer end of the Duck-bill. In addition to the SEN1 areas, we also have other areas where the Federal Maritime and Hydrographic Agency has identified potential for offshore electrolysis. A great deal of research has been carried out in recent years on the ramp-up of the technology, and now it is being developed and scaled up. Offshore electrolysis will work and play an important role in the energy mix.

Nevertheless, the global construction activities of the offshore wind industry could put the brakes on the plans. Is there even enough capacity for installation vessels?

This is indeed a challenge that the entire offshore industry has to face. Installation vessels build the wind turbines and we need them in any case, regardless of whether I only want to generate electricity or hydrogen. However, the decisive advantage of AquaVentus lies on the cost side. I don't need laying ships for expensive submarine cables, but only ships for pipeline construction. The capacity situation is less tight in this segment. With AquaVentus, we are even providing some relief for the urgently needed expansion of the electricity grid. 

Compare!

Cost-effective ROBA-stop® brakes

- ✓ up to protection class IP 67
- ✓ proven in ships and harbours worldwide
- ✓ with innovative brake monitoring

 **mayr**®
your reliable partner

 www.mayr.com



Visit us at WindEnergy: Hall B5 / Booth 425



The areas of applications for marine technology are vast

Source: Fugro

Marine technology is crucial for the offshore wind industry

BLUE ECONOMY There is no doubt that the oceans will be the next major area for future business applications. Innovation and investment are two sides of the same coin that drive economic activity in the oceans. To meet the growing global demand for more renewable energy, higher efficiency, resilient supply chains and other expanded commercial opportunities in a sustainable way, the development of the blue economy, especially marine technology, is crucial.

Offshore wind resources are imperative for the energy transition. 380 GW of offshore wind capacity, across 32 markets, is predicted to be added in the next ten years according to the Global Wind Energy Council. As offshore wind farms experience more challenges related to design, fabrication, installation, operation and maintenance, and lifetime extension compared to onshore wind farms, a more integrated involvement of the marine technology industry will definitely be required. Three decades have passed since the first offshore wind farm was constructed. Today, offshore wind energy has been rapidly evolving with the aim of deploying larger wind turbines at increas-

ing water depths and under complex external conditions. Recently, floating wind power has attracted interest as part of the exploration of deeper waters with undisturbed higher wind speeds. The installation of floating wind turbines brings additional degrees of freedom that affect the performance and safety of the turbines. Therefore, sustainable design, construction, and installation methods, hydrodynamics, aerodynamics, and controls of such structures are different from solid structures and require special attention and application of marine technology.

Due to the increased involvement of marine technology companies, there has been continuous progress in foundation design, control strategy, transport and installation methods, marine operations execution, computational methods, and model testing, just to name a few.

The global offshore wind market grew at almost 30% every year of the last decade, benefiting from rapid technological improvements. Today, more than 100 new offshore wind projects are under active development worldwide.

Europe was driving the development of the technology, led by the UK, Denmark, and Germany, but China added more capacity recently than any other country. Now the United States and other Asian markets are also becoming more involved.

However, today's offshore wind market is far from realising its full potential – with high quality resources available in most major markets, offshore wind has the potential to generate more than 400,000 TWh per year globally. That's almost 20 times the world's electricity needs of today. The German Association for Marine Technology (GMT) is already a major contributor to a smart and sustainable energy transition toward offshore wind. Its members are heavily involved in offshore wind projects and operations, including bathymetric surveys, acquiring aero- and hydrodynamic data, design, fabrication, installation, inspection, decommissioning and repowering of offshore wind farms. Based on this, the GMT network creates continuously new opportunities to exchange and explore new horizons in research, development and business applications.



ACCOMMODATING A FUTURE LARGE ENOUGH

At the Port of Ystad, we refuse to let size limit your ambitions. Nestled along the serene Swedish south coast, our port stands as a beacon of opportunity in sustaining the transport industry.

Our facilities are tailored to accommodate cargo of all scales, from the smallest parcels to the mightiest of ferries.

This is a port where even transporting a towering wind turbine is a seamless endeavor.

We redefine the boundaries of logistics and accommodate a transformative journey that's waiting to be explored.



Port of Ystad

www.port.ystad.se

Our port is the hub of your logistics chain. A place where tourism, cultures, cargo, services, jobs and development meet. A region to be inspired by, a city to invest in and a safe port to call home.

Converter platforms made in Germany

DOLWIN DELTA Meyer Werft in Papenburg recently saw first steel cut of the *DolWin delta* converter platform. It is the first project of its type in Germany and a total of four platforms will be built for a major development in the country's energy transition. It will also create a large number of jobs and provide the country with greater energy resilience and national security, writes freelance journalist Frank Muth.

The speakers considered the steel-cutting ceremony of the *DolWin delta* converter platform at the beginning of July at Papenburg's Meyer Werft a clear signal: "The decarbonisation of Europe is underway!" Lower Saxony's Minister of Economic Affairs, Olaf Lies, recalled that the vision of offshore wind farms was ridiculed just a few years ago. Since then, dramatic progress has been made in terms of the sector's development, demonstrating why climate protection, jobs, value creation, prosperity and resilience should all be considered together, as this is the only way to achieve social acceptance for progress on climate protection.

In his sometimes passionate speech, Amprion managing director Peter Barth pointed out that high energy prices are not the only explosive force in society – which is why relatively cheap wind power is needed – but also the relocation of jobs from Europe to Asia. It is for this reason that Amprion is now having four converter platforms built in Germany.

Securing German jobs was also a focus of the ceremony at the Meyer Werft shipyard in Papenburg, which has fallen into crisis. The order is an opportunity to expand the company's portfolio with the construction of components for converter platforms, explained Jan Meyer, Chief Business Innovation Officer of Meyer Group. The shipyard will use the laser hybrid welding process it has already established for construction and thus transfer its expertise from shipbuilding to other maritime sectors.

More capacity needed for the expansion of offshore wind farms

Dieter Janeczek, maritime coordinator for the German Government, added that German shipyards had realised that they would have to broaden their base in the future. According to him, the commissioning of Meyer Werft shows that it is possible to create new production capacities for the energy transition in Germany. The further expansion of offshore wind farms in the North



Illustration of the converter platform

Source: Amprion

and Baltic Seas (from 8.9 GW today to 30 GW by 2030 and up to 70 GW by 2045) will require more production capacity for the construction of large converter platforms. Shipyard locations in Rostock, Kiel, Bremen and Bremerhaven could also benefit from this. The special guarantee programme for the construction of onshore converters and offshore converter platforms, launched by the Federal Government and the German coastal states of Lower Saxony, Bremen, Hamburg, Schleswig-Holstein and Mecklenburg-Western Pomerania, will support this.

Amprion's Barth also argued in favour of a rapid expansion of production capacity, as only then could the ambitious timetables for offshore wind energy be met. According to the wind power associations, current capacity will enable a maximum of only 27 GW to be commissioned by 2030. Furthermore, it should not be forgotten that total capacity of up to 400 GW could be installed at sea in Europe in the long term, requiring around 140 converter platforms.

This would probably be sufficient to ensure the long-term, if not permanent, use of production capacity. After all, once the last turbines have been installed, the oldest turbines will have to be replaced.

Converter platforms are necessary for more resilience

Economics Minister Lies spoke of the "North Sea powerhouse" and campaigned for wind to be seen as a new environmentally friendly raw material that would make Germany both less dependent on fossil fuels whilst also enabling the creation of entirely new value chains. Offshore wind farms, for example, may soon ensure that green electricity arrives at inland locations and could be used for hydrogen production, for example.

The issues of offshore wind power, job preservation and European security are also closely linked. If shipyards and industrial facilities, skilled labour and expertise were to disap-



pear, it would be very difficult to rebuild such resources. However, having these domestic capabilities and capacities is absolutely essential for an active security policy in the face of new geopolitical challenges, because only then would Germany and Europe have the security to react appropriately.

This is particularly true for shipbuilding. Only domestic shipbuilding facilities will guarantee that Germany remains independent from other countries and regions for the implementation of key technologies. This is also true for the construction of marine vessels and defence units for the German Navy.

That is why it is important to commission shipyards with new projects such as the construction of components for converter platforms, for example. During the steel-cutting event in Papenburg, it also became clear that military vessels will also be needed to protect large wind farms against attack. After all, offshore wind farms will one day cover around a quarter of all coastal areas. This closes a circle: offshore wind is needed for energy security and resilience, but offshore wind farms also need security themselves.

According to Lies, many more technological products will have to be manufactured in Europe again if the issue of 'safety' is to be taken seriously. However, this would require the specific location of production sites in Europe to be given greater consideration in tenders. Lies demanded that in future, the focus should not only be on costs, but also on resilience and safety.

Converter platforms as the centrepiece of offshore expansion

Amprion commissioned the Spanish company Dragados Offshore and Siemens Energy to build the converter platforms in 2022. Dragados subsequently awarded parts of the production process to Meyer Werft in Papenburg at the end of 2023.

The production of platform components at the yard will total around 43,500 tonnes of steel. Of this, about 11,500 tonnes will be used to manufacture sections for the *DoWin4* and *BorWin4* grid connection systems. For the *BalWin1* and *BalWin2* offshore connections, another 32,000 tonnes will be needed.

Amprion uses direct current technology to transmit wind power from the offshore wind farms. This enables large amounts of energy to be transported with low losses. Converter stations at sea and on land are required to convert alternating current into direct current and vice versa.

From the North Sea wind farms, cables initially run between 60km and 125km at sea before crossing under the island of Norderney



Political and economic prominence at the ceremony in Papenburg

Source: F. Muth

and to reach the coast. From there, the underground cables run to the Hanekenfähr substation in Lingen (Ems), 155km away.

Only there will they be connected to the Amprion transmission grid. The Emsland nuclear power plant near Hanekenfähr was shut down in April 2023. The resulting loss of generation capacity is to be replaced by

1.8 GW of offshore wind power, which is roughly equivalent to the demand of the city of Hamburg with its 1.8 million inhabitants.

The *DoWin4* and *BorWin4* grid connection systems are likely to be commissioned in 2028 and will then transmit a capacity of 900 MW each. The cables are already under construction.



CUXPORT – IN POLE POSITION

The x-press link to sea

- /// Daily Ro / Ro vessel to / from UK
- /// Handling and Storage of Components for the Wind Industry Onshore / Offshore
- /// Modern Multipurpose Terminal for Project Cargo, Break Bulk, Containers and Automobiles

Cuxport GmbH · Neufelder Schanze 4 · 27472 Cuxhaven · Deutschland
T. +49 (0)4721 748-0 · info@cuxport.de · www.cuxport.de



High potential as structures move

EU PROJECTS Floating offshore wind opens the door to sites further offshore by allowing the deployment of wind turbines in larger and deeper offshore areas harnessing more energy. Projects in Norway, Scotland, and Spain have shown how much potential those structures entail, as Charlie Bartlett reports.

This year, classification society DNV gave its approval in principle (AiP) to a seemingly insane structure which nonetheless may become the future of floating offshore wind. Norway's Wind Catching Systems (WCS) has designed what can best be described as a wind turbine wall, equipped with dozens of 1-MW turbines in a staggered configuration.

While economies of scale in offshore wind favour blade length and overall turbine size, the Windcatcher is designed to work differently, using many small and well-established turbine designs instead. While the DNV-certified model is 40 MW – still a 300m-high behemoth – WCS believes that as much as 126 MW of turbine generation could be supported by a floating Windcatcher structure.

The system helps overcome one of the major challenges of offshore floating wind – scalability. Theoretically, floating turbines do not require a wind turbine installation vessel (WTIV) to be put in place, requiring only to be towed into position. This means that the turbines are limited by material science and manufacturing capability, and a need to make taller towers and longer polycarbonate blades.

The first of these systems will be used to kick-start the Norwegian offshore wind industry, which thus far is only equipped with a handful of floating turbines. Enova, an investment fund operated by Norway's Government, is submitting some NOK 900,000 for the construction of a prototype Windcatcher, for installation off the coast of Øygarden.

The offshore wind industry in Norway seems to be swimming against the current, implied Ingrid Due-Gundersen, CEO of Havfram. Newly minted, her company was spun off from offshore oil and gas player Ocean Installer in 2022, and has been a pure-play offshore wind concern since. "I think [in Norwegian offshore wind] it's the companies that have established themselves, not necessarily the political backing of them," Due-Gundersen said. "The reason why Norwegian companies are good enough to win is the maritime background.

"Typically in Norway, it is thought that you have the oil and gas industry, so you don't really need the wind."

Indeed, Norway is able to satisfy its domestic energy needs using renewable hydropower, entailing a surplus of around 21 MWh, and while it is heavily involved with the offshore wind industry in other countries, the appetite for domestic installations is diminished, Due-Gundersen explained. "You have this argument that the production of oil and gas in Norway is better than anywhere else in the world. It's cleaner, and I think this takes down a little bit the [offshore wind] initiatives. But, if you're in Denmark, for example, you have to have some kind of additional energy source."

Adding to this is the main challenge for offshore wind in Norway – water depth. With a continental shelf that drops off dramatically in Norwegian waters, in contrast to that of the UK, France and Germany and Denmark, the high cost of floating turbines has deferred greater investment.

But recent developments show that this might change – where there is deemed to be the right business case. Activated in August last year, Norwegian floating wind farm *Hywind Tampen* has been making waves, powering Norwegian oil and gas platforms. Set some 140km out to sea, and in water depths of as much as 300m, the ambitious installation generates some 88 MW for a network of nearby oil and gas platforms.

This synergy between renewables and fossil fuels might not do much to impress environmentalists. But the installation is a landmark both in terms of its size – being the largest offshore wind farm currently in existence – and also in what it represents. It is a pragmatic application of renewable energy well out to sea, where, like it or not, offshore exploration is heading further away and into deeper and more challenging waters, and generating considerable CO₂ emissions in the effort.

It is clear that Norway can make exceptions where a case can be found. "If the political system decides to go in that direction, they're going to manage to do it. But I see how challenging it has been here in Norway, for example, to actually get everybody to agree on the way to go," Due-Gundersen declared.

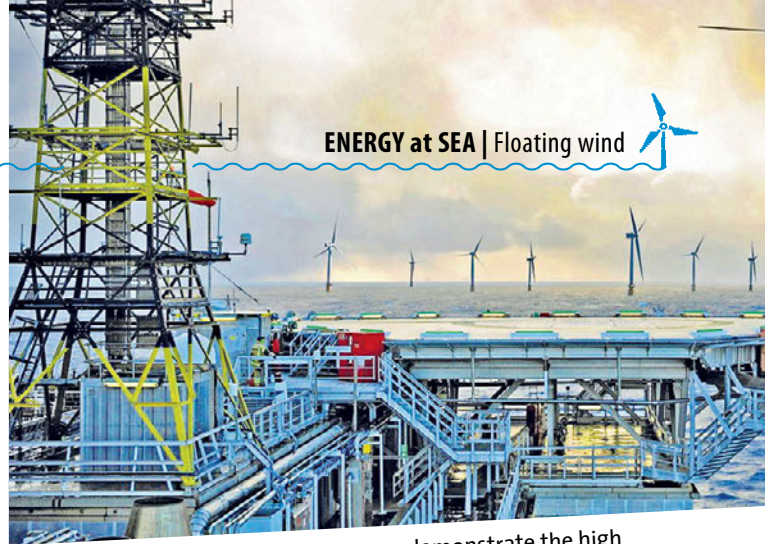

Floating offshore projects across Europe demonstrate the high potential of yielding more energy by moving structures further to sea
Sources: Equinor (left and right); X1 Wind (middle)

further to sea

But that time may soon arrive. In 2021, the North Sea Link (NSL) was commissioned, linking Norway's power grid with that of the UK. A similar connection, Nordlink, connects it with Germany. In the months that followed, energy costs in Norway soared, going from NOK 0.61 in February 2021, to NOK 5.43 in August 2022, as Norwegian hydropower was sold to European customers at European prices.

It was a rude awakening for electricity-profligate Norwegians, who are the seventh highest per-capita energy users in the world. If there was not political will to invest in greater electricity production before, there is certainly be in the coming years.

Scotland to reclaim floating wind accolades

Scotland was briefly home to the largest floating offshore wind array in the world, the 30-MW *Hywind Scotland*, which opened in 2017. It was soon surpassed by 88-MW *Hywind Tampen*. But the Scottish offshore wind cluster remains a hotbed of activity in the realm of floating turbines, and one of the latest projects to be announced, *GreenVolt*, would reclaim the title for Scotland – but there is a catch.

Located at a site 75km northwest of the Aberdeenshire coast, *GreenVolt*, a 50/50 joint project by Flotation Energy and Vårgrønn, would comprise some 35 turbines, capable of producing 560 MW. But like *Hywind Tampen*, this energy will be used to power oil and gas platforms.

The project garnered planning approval from the Scottish Government in April. At the time, Flotation Energy CEO Nicol Stephen said: "It is fantastic to have received the green light to deliver the world's biggest floating offshore wind project, right here in the Scottish North Sea. "This major milestone places Flotation Energy and our Joint Venture Partner, Vårgrønn, firmly at the heart of the energy transition."

Like *Hywind Tampen*, ensuring they benefit the oil and gas industry appears to be the safest route to getting the investment required to build floating wind farms. However, there can be no doubt that the construction of the new largest floating turbine installation in the world will provide the necessary knowledge and industrialisation capacity to bring down the cost of floating wind, far enough that it can benefit the whole industry, as well.

"This multi-billion-pound development can now move forward confidently, creating hundreds of local jobs and proving that the UK and Scottish supply chain is ready to deliver commercial-scale floating

projects, at pace," said Stephen. "Flotation Energy is headquartered in Scotland with its roots firmly in Aberdeen and the North East. We are already drawing on the world-class energy skills and experience of the region – and now look forward to doing far more."

Spanish wind armada sets sail

At the other end of Europe, Spain has a similar problem to Norway. Although blessed in terms of an abundance of coastline, much of it falls very quickly into deep water unsuited to fixed-bottom turbines. Areas with the greatest wind potential are to the northwest off Galicia; the Mediterranean off Catalonia; and to the south, within the Strait of Gibraltar. According to the Global Wind Energy Council (GWEC), the 207-GW potential for floating offshore wind in Spain vastly outstrips the meagre 12 GW available for fixed turbines, making it one of the most viable candidates in Europe for a floating wind revolution.

Surprisingly, it is wind, and not solar, which seems to be Spain's renewables favourite. In 2023, it generated 50% of its electricity from renewable energy, of which wind, at 23.3%, was the biggest component.

In July this year, the NextFloat+ project, helmed by Barcelona-based X1 Wind, received some EUR 13.4 million in EU funding, via the European Commission's Innovation Fund, to support development of a new floating turbine, the 6 GW X90. Another attempt at bringing down the total cost of floating turbines, the design consists of a tripod supported by a tension-leg platform with a single mooring point to reduce weight.

Instead of turning to meet the wind like a conventional turbine, the single-point mooring allows the X90 to 'weathervane', passively swivelling toward the best angle. In doing so, the turbine cuts down on components, steelwork, cost, and time to market. Meanwhile, dividing one large tower into three separate lightweight tubular members means that none must meet conventional standards of wind resistance on its own, thereby making them easier to manufacture and transport.

With the first X90 demonstrator turbine installed at the *Plataforma Océánica de Canarias* (PLOCAN) test site in the Canary Islands, X1's aim is to scale up production, together with NextFloat+ project partners Technip Energies and NextFloat Plus S.A.S., to the point where larger turbines, with a 240m blade diameter, can be built. If it achieves its goal, the Iberian Peninsula will be first in line for a major floating wind overhaul. ~

Denmark on the way to CCS infrastructure



Wintershall Dea and the British Ineos Group received an exploration licence from the Danish Energy Agency in June to examine the potential for underground storage of carbon dioxide at the Gassum site. The consortium partners want to store up to 250 million tonnes of the gas 75km north of Aarhus.

The German group is marketing the project under the name 'Greenstore' and it could open up new prospects for the Port of Hirtshals as a CO₂ hub. A CO₂ pipeline is to be built between Gassum and Hirtshals, and Greenport Scandinavia is to be established in the harbour town as Northern Europe's largest hub for carbon capture, utilisation and storage (CCUS).

"The potential for safe storage in Gassum is great, but now we must carry out the necessary studies to demonstrate safe and efficient storage in Gassum, and naturally, we will draw on the important learnings from Greensand," said Mads Gade, country manager of Ineos Energy Denmark.

Wintershall Dea and Ineos are also involved in the Greensand offshore project together with Nordsøfonden, the Danish state-

owned company responsible for underground resources, in particular oil and gas production and geological CO₂ storage. Here, in the *Nini West* reservoir near the *Siri* oil field in the Danish North Sea, it should be possible to store up to eight million tonnes of CO₂ per year from 2030, the partners forecast.

This corresponds to around a quarter of Denmark's total emissions, meaning that the CCS storage site would have the potential to provide all of the CO₂ storage capacity targeted in the Danish climate protection programme. Following an initial successful offshore injection last year, a CO₂ storage capacity of 0.4 million tonnes per year is now to be built up by 2025, which is then to be scaled up to 4-8 million tonnes per year by 2030.

"The allocation of the Gassum license not only promotes Greenport Scandinavia's vision, but also underlines the relevance of the port expansion in Hirtshals. With the new license we can integrate both shipping and loading of CO₂ into the project, which significantly increases the overall capacity. Access to two storage locations means that we can handle much larger amounts of CO₂, which is tremendously

exciting", said Per Holm Nørgaard, CEO of Port of Hirtshals.

Denmark had already set the political course four years ago to enable CCS. "CCS is an important instrument for achieving the Danish reduction target of 70% by 2030," explained Anders Hoffmann, Deputy State Secretary at the Danish Ministry of Climate, Energy and Utilities.

"A broad social majority supports the project, but it is also clear that CCS must not stand alone," he declared. "We must continue to use energy efficiently and promote the expansion of renewable energy and green technologies, but in certain sectors it is currently not possible or still too expensive to reduce all emissions. This is where CCS technology is needed."

Denmark wants to be climate-positive by 2050 and then achieve a reduction target of 110%; to reach this, CCS must also be extended to biogas plants and biogenic sources in the utility sector, explained the Deputy State Secretary.

It is also about industrial sectors that have few other options for decarbonisation,

such as waste incineration or the cement industry. Aalborg Portland, the largest cement plant in Europe, is located in the far north of Jutland. Around two million tonnes of CO₂ are released into the atmosphere here every year, making it Denmark's largest CO₂ emitter.

From 2030, CO₂ capture is to be tested here on an industrial scale; the operator then wants to remove up to 400,000 tonnes of CO₂ from annual production and thus save around 18% of total emissions. Wind and solar plants with a total output of 76 GW are currently being planned around the main plant on the Limfjord, as the energy-intensive CO₂ capture process is likely to double the cement plant's electricity consumption.

The captured CO₂ is to be transported north via a pipeline to the port of Hirtshals, around 60km away. From there and from the southern Danish harbour town of Esbjerg, CO₂ transport by ship to the North Sea are planned in order to store the gas in disused oil and gas fields.

Licences for the *Bifrost* and *Greensand* offshore storage facilities had already been awarded in 2022, and the first CO₂ storage was carried out in an offshore pilot test a year later. The Geological Survey of Denmark and Greenland (GEUS) estimates the geological storage volume in Danish onshore and offshore storage formations at up to 22 billion tonnes of CO₂.

"The Danish storage potential is much greater than the Danish demand," noted Pål Krogh Tygesen, CCS team leader at the Danish Energy Agency. It is therefore not surprising that Denmark is looking for partners among

neighbouring countries to build up a CCS value chain.

In addition to the three offshore licences for the *Bifrost* and *Greensand* fields, which Denmark awarded in 2022, the onshore licences for *Gassum*, *Havnsø* and *Rødby* were added this summer. The two onshore reservoirs *Thorning* and *Stenlille* as well as the three offshore fields (*Inez*, *Lisa*, *Jammerbugt*) are expected to be licensed by the end of the year.

"Our task is to define suitable areas for geological CO₂ storage based on the geological structures. Denmark has a large number of suitable structures (marked in green on the map, editor's note), 14 of which we have evaluated," said GEUS geologist Nina Skaarup. She is the authority's spokesperson and informs the public about CCS, the geology and the ongoing data collection.

But Skaarup also makes it clear: "We are not doing this to convince people about CCS, there is a clear climate policy decision that the CCS process should be implemented in Denmark." Nevertheless, Skaarup has to clear up prejudices and misinformation. "The CO₂ is separated from the flue gas, compressed and transported to suitable storage sites. There it is pumped into the reservoir of the storage facility via deep boreholes and then lies well below the layers of groundwater," she explained, thereby dispelling one of the widespread concerns that CO₂ storage could contaminate groundwater supplies.

In addition to Wintershall Dea and Ineos, the gas network operator Evida, Biocarb Solutions, the cement manufacturer Aalborg Portland, the municipal development company

Greenport Nord and the harbour operating company Port of Hirtshals are involved in the Greenport Scandinavia Initiative. The players want to establish commercial value chains across geographical and industrial sectors in order to capture, transport, store or utilise CO₂. The potential is also raising ambitions in Aalborg to the south, as the port of Aalborg also plans to utilise the locally produced or imported CO₂.

Together with the US project and technology developer Fidelis New Energy, the Port of Aalborg plans to commission the first large-scale plant for the treatment of captured CO₂ in 2026. Alongside the Siemens Gamesa rotor blade plant and the connected multimodal green logistics terminal, CCUS will become a new business area for the port. In future, around four million tonnes of CO₂ per year will be converted into synthetic fuels, so-called e-fuels, or stored using Power-to-X technology.

"We are very pleased that the project in Aalborg is being realised. The new facilities will be an important part of our work to support European companies' commercially proven climate strategies. The storage and utilisation of CO₂ is a key element of most national and international climate targets," said Ulrik Dan Weuder, managing director of Fidelis Europe.

The project is expected to create an additional 5,000 jobs in the Port of Aalborg by 2030, while at the same time the port will contribute to further reducing CO₂ emissions by 2030 with the new business areas. This sustainable approach is also intended to create trust and acceptance among the local population.



Aalborg Portland's cement kilns emit around two million tonnes of carbon dioxide per year Source: Aalborg Portland Holding

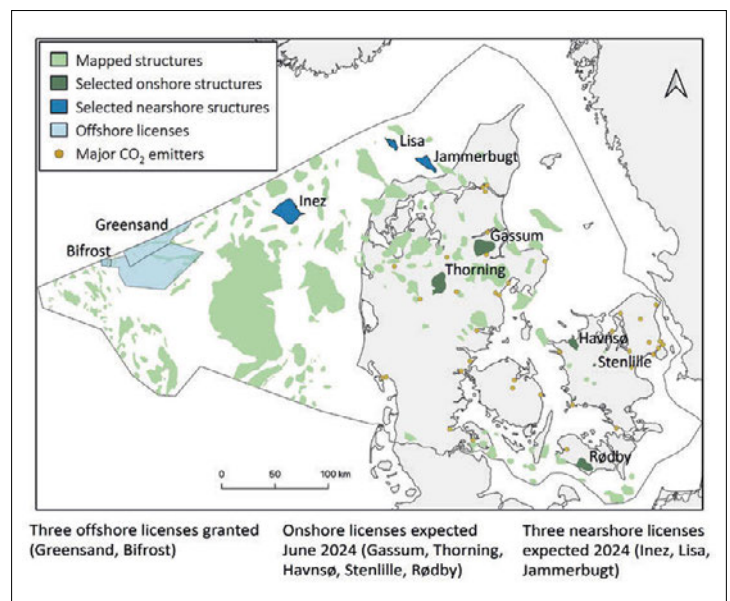

Location of the licensed CO₂ storage facilities and the main emitters Source: GEUS

Global projects still in their infancy

PROTOTYPES While hydroelectricity provides incredible continuous renewable power in China, Brazil and Norway, its applications are limited, and those that can be developed have been almost entirely exploited. Wave energy is almost completely generated by the movement of wind across the sea surface, but offers a route to a much more thorough exploitation of its energy.

There are some 1,500 wave energy patents in existence from as far back as the early 1800s, demonstrating that the notion of harnessing wave power is nothing new. Harvesting momentum from waves ought to be easier than other energy sources; waves are available 90% of the time, three times more than wind and solar; and sea water is, after all, hundreds of times denser than air.

But the fact that the world is not yet awash with such devices shows that, in general, it has been surprisingly tough to convert the reciprocating motion of waves into the rotary motion necessary for power generation than wind or solar energy. Unlike mature renewables sectors, each new wave energy project is, to some extent, a prototype.

Oscillating water column

One strategy is currently being tested off Oahu, in Hawaii. Ireland's Ocean Energy has developed a buoy, part funded by the US Department of Energy as well as Ireland's Sustainable Energy Authority, comprising three underwater chambers, with water levels rising and falling inside them. As the chambers fill, they push compressed air through a turbine. Then, as the chambers empty, air is sucked into the system from outside, also generating energy to be harvested by the turbine. This wave energy harvesting principle is known as an 'oscillating water column'.

The system's extraordinary 826-tonne weight is a key element of the structure, as displacement of the water is an essential part of the process. Ocean Energy claims that its OE35 – the model currently in testing off Hawaii – can generate some 1.25 MW. A specially-designed Siemens turbine is capable of harvesting energy from air going in either direction in or out of the buoy, while still turning in the same direction. In due course, Ocean Energy plans to scale up further, delivering the OE50, a system with some 2.5MW of generation capacity.

A similar system, the Wave Swell Energy (WSE) Uniwave 200, is being tested off King

Island, Tasmania. The 'artificial blowhole' system features a single concrete chamber, with a unidirectional turbine that only generates energy on the downstroke, as water levels inside the chamber decrease, which simplifies maintenance. Although the system is designed to be towed out to sea, WSE envisions its systems being built into breakwaters and quay walls, construction of which is becoming increasingly urgent in many economies due to rising sea levels. According to WSE, the system can convert wave energy into power with an efficiency as high as 50%.

Point absorption

Back in Europe, one system has exceeded expectations both in terms of efficiency, and in respect of another major concern for potential wave power systems – survivability. CorPower Ocean (not to be confused with maritime nuclear energy advocate Core Power) is a Swedish developer of 'point absorber' wave systems, the term used to describe a floating tethered structure that harnesses energy from the bobbing motion waves create.

Inside each gourd-shaped CorPower buoy is an oscillating system known as a

wavespring. As waves push the floating system upward, power is stored in a compressing pneumatic cylinder which then releases its energy to push the buoy down. On both upstroke and downstroke, a system of gears at the centre of the system transforms this reciprocating motion into rotational energy.

One particularly clever piece of engineering allows the buoy to change the rate of reciprocation to match the wavelength of the ocean surface. Similar to parametric rolling on a ship, this allows the buoy to capture wave energy with the highest possible efficiency. Fully contained within the composite fibreglass buoy, the wavespring is protected from corrosion, as well as being able to 'de-tune' to prevent the system being damaged in a storm.

Installed off Porto, Portugal, in September last year, the first commercial scale CorPower buoy has since withstood four Atlantic storms without issue. In its next phase, CorPower envisions installing 'wave farms' comprising 'blocks' of 28 buoys, capable of generating 10 MW.

Surface attenuation

At the Plataforma Oceánica de Canarias (PLOCAN) test site off the Canaries, efforts are underway to co-locate windfarms and wave farms with hydrogen generation. Floating Power Plant (FPP) is currently developing the SEAWORTHY ('Sustainable dispatchable Energy enabled by wAve-Wind OffshoRe platforms with onboard HYdrogen') project, a floating platform which will combine a 4.3MW wind turbine with a 0.8 MW 'surface attenuator' wave system, providing a near-continuous supply of power even when the wind does not blow.

Whichever of these companies gets wave power right, the gains to be made are extraordinary. Some 29,500 terawatt-hours (TWh) of wave energy could be harnessed globally, according to figures from the UN Panel on Climate Change – around 20% more than the world's entire electricity consumption. 



Source: CorPower

The first of CorPower's buoy is installed off the coast of Portugal

GMT

German Association for Marine Technology

**Bundled competence in
marine technology for
exploration, protection and
sustainable use of the oceans**

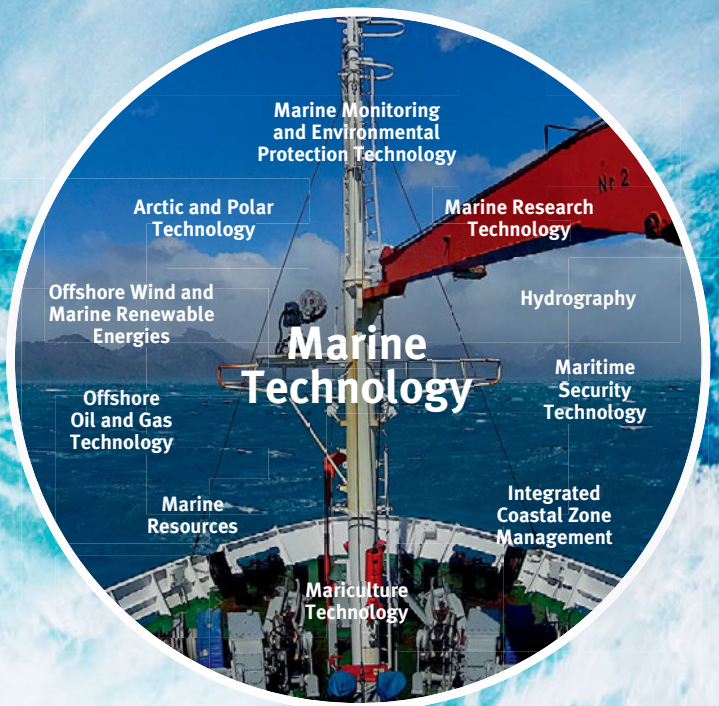

Benefit from the network!

- **Marine technologies for future needs**
- **Cooperation between business and science**
- **A unique network in marine engineering**

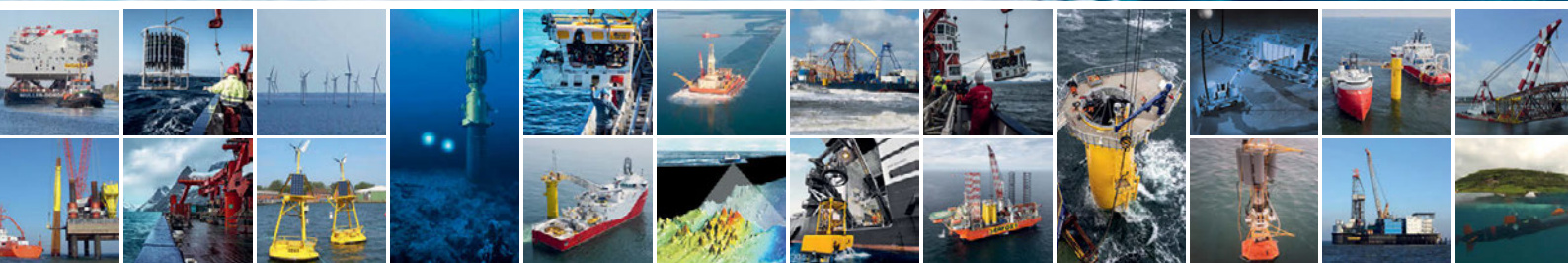

www.marine-technology.eu

A “varying degree of preparedness”

CARBON TRADING Freelance journalist Patrik Wheatler explores how shipowners and managers that embrace the EU ETS and the requisite carbon trading processes will gain a competitive edge

The European Union’s Emissions Trading System (EU ETS) is now being phased in to cover carbon dioxide (CO₂) emissions from ships over 5,000gt, and the UK’s Emissions Trading Scheme Authority has now confirmed that domestic voyages between UK ports will come under the regulation from 2026. Is the shipping industry ready for carbon trading? Not entirely, it seems.

According to Iain Stevenson, Carbon business development manager, Carlton Carbon, an organisation helping the industry comply with its ETS obligations, there is a “varying degree of preparedness”. However, failure to comply will be costly – if a shipping company has failed to cover its emissions by the end of its compliance year, it will cost EUR 100 per tonne of CO₂e.

Speaking during a panel discussion on decarbonisation at a recent industry forum in Hamburg, Stevenson said: “There is a big divide between those companies that have taken the challenges on board and understand the complexities, and those that have taken a back seat. Shipping is known for having a wait-and-see attitude ... but there is some denial because tough decisions often mean more cost. There is this divide emerging across the industry.”

Carlton Carbon sees those companies that have acknowledged EU ETS as a positive step as being more proactive in ensuring that processes, such as data capture and the purchase of allowances, have been set up correctly.

“This really is important because [the market] is only going to get more aggressive. The shipping industry must be more proactive in understanding what is required.”

As an aide memoire, the EU ETS – the world’s largest carbon compliance market – was set up in 2005 to reduce carbon emissions by capping the amount of CO₂e that companies can generate through their industrial processes. By putting a price on CO₂

and gradually reducing the supply of allowances [carbon credits], companies falling under the regime are incentivised to use cleaner fuels.

They must surrender allowances equal to their emissions on an annual basis. Allowances can be traded via the European Energy Exchange (EEX), the Intercontinental Exchange (ICE) or through a trading partner, like Carlton Carbon.

Stevenson anticipates more frequent and fluid trading of ETS allowances, with volumes becoming much smaller to reduce exposure. This is indicative in the decision by ICE to launch a mini-derivative, moving the CO₂e allowances traded from 1,000 tonnes to 100 tonnes.

“Shipping has been lucky not to be included in this system until now as it is a huge global polluter,” Stevenson said. “ETS works and is a powerful and positive climate management tool. Now is the time to embrace the change, not fight against it.”

Some are more prepared than others. Norwegian chemical tanker operator Odfjell, for example, started to put systems to manage ETS processes in place several years ago.

Speaking during the same panel discussion, the shipowner’s chief sustainability officer Øistein Jensen explained how the company combined its own infrastructure and data capture system to allocate the different amounts of CO₂e allowances to different customers.

“It is essential that we are able to do this,” he said, urging delegates not to forget the underlying purpose of ETS. “It’s not there to provide revenues to the EU, it’s supposed to drive behaviour, it’s supposed to drive change. And if we are not able to do that, if we consider it as just another added cost, then it will become just another tax that just increases the cost level. We need to make sure we can make it transparent.”



Ulla Eithz Nielsen, managing director of the German branch of V.Ships



Øistein Jensen, chief sustainability officer at Odfjell



Iain Stevenson, Carbon business development manager at Carlton Carbon

Jensen said visibility of a shipping company's ETS position means that charterers would be more incentivised to charter vessels with the lowest CO₂e, even if it may cost more.

"It's extremely important ETS and other market-based measures drive behaviour. It's really important for us to decarbonise our business in order to be competitive," he said.

Jensen explained that the managing, reporting and validation (MRV) management system Odfjell has introduced can collect ship emissions data in almost real time. Once captured, internal performance teams assess and validate the data to calculate ETS much earlier. It also automates and standardises reporting. "It makes ETS easier," he declared.

However, allocating part of a voyage to different customers/charterers/shippers can be complicated when a ship is carrying a diverse range of cargo consignments. To this end Jensen advocates adoption of the Sea Cargo Charter methodology which, he said, could also help with the increased demands of Scope 3 emissions reporting.

"Data is crucial," he said. "Transparency, traceability, auditability; it is going to be huge. It also has the capability for some companies to use it to their competitive advantage."

Shipmanager V. Ships has also established processes in good time to ensure that its shipowning customers are compliant. However, Ulla Eithz Nielsen, managing director of the company's German branch noted that "some don't want to be bothered by all of this. They just want us to fix it, get it done, make sure they comply."

Nielsen explained during the Hamburg forum that the ship manager has established a "centre of ETS excellence" at its Hamburg office to serve all V. Group offices and customers globally. She added that the company implemented an ETS management system about five years ago to capture emissions data from its fleet of 600 ships automatically, with all the information accessible via one platform.

"Implementing a system is not difficult but using it right and using it every day is very difficult," she told delegates. "But we have the experience now and we are in a good place to manage it. If we didn't have this [system], it would be a very, very complicated process to manage all of the data. I would say impossible. You do need a strong solid system, one system to manage everything... we can handhold our customers all the way through [the process]. We are ready"

Commenting on 2025, the first year in which the shipping industry will have to surrender data on the previous year's emissions, Nielsen said the administrative part "will be enormous" because of the potential impact of liabilities.

Stevenson agrees: "The first EU Allowance (EUA) surrender deadline for shipping emissions may not be until September 30, 2025, but there is a lot more to do before then than just setting up a Maritime Operator Holding Account (MOHA)," he said.

"Shipping companies that find themselves exposed to ETS regulations will need to choose a carbon trading partner, set up new compliance processes, decide on a purchasing strategy, and budget accordingly for additional costs they will now be incurring for the right to pollute. But most importantly, it's about seeking the right support so that they understand the market and appreciate that EUAs are a volatile, freely traded commodity. Ultimately those companies that prepare and engage with the ETS will gain a competitive edge over those that do not."

13TH INTERNATIONAL VALVE TRADE FAIR & CONFERENCE

MAKE YOUR BUSINESS FLOW



03-05 DECEMBER
2024
DÜSSELDORF GERMANY

VALVEWORLDDEXPO.COM

Sponsored by:



Messe Düsseldorf GmbH
P.O. Box 10 10 06
40001 Düsseldorf_Germany
Tel. +49 211 4560 01

www.messe-duesseldorf.de





The key issue for FuelEU Maritime is that reporting complexity will increase

Source: Coach Solutions

FuelEU Maritime: baselines, incentives, penalties and compliance

CARBON ACCOUNTING The EU's Fit for 55 package will change the way we think about fuel and carbon accounting, writes Christian R   Holm, managing director at Coach Solutions, a software creator for the shipping industry

The European Union's FuelEU Maritime regulation will be in force from January 1st 2025, as part of the 'Fit for 55' package which has the goal of reducing carbon dioxide (CO₂) emissions within the bloc's maritime sector by 55% before 2030, compared with 1990 levels. As a complement to the introduction of the EU Emissions Trading System (ETS) to shipping in 2024, FuelEU Maritime is designed to promote the consistent use of renewable and low-carbon fuels in the maritime sector.

Its requirements are seemingly simple on paper, but far less so in practice. The average greenhouse gas (GHG) intensity of fuel consumed on EU voyages will be steadily reduced, starting with a 2% reduction between 2025 and 2030. The reduction factor is increased in steps every five years until it peaks at 80% in 2050.

The baseline is 91.16g of CO₂ equivalent per megajoule (gCO₂e/MJ) of consumed energy, which was the average GHG intensity in the maritime sector on EU voyages based on MRV reporting in 2020. Similar to the application of the ETS, the GHG intensity requirement applies to 100% of fuel consumed between EU ports and EU port stays, and 50% of the fuel consumed

on incoming and outgoing voyages to or from an EU port.

In theory what this means is that approximately 2% of the fossil fuels previously consumed on EU voyages should be replaced by emissions-free fuel. This is of course a major simplification as emissions-free fuels do not exist when carbon emissions are considered on a well-to-wake basis, which is how FuelEU Maritime assesses them.

A better and more realistic example may be that 4% of fossil fuels on "FuelEU applicable voyages" should be replaced by green fuels to achieve a 50% reduction in GHG intensity. Or 8% of fossil fuels replaced with fuels with a 25% GHG intensity reduction and so on.

An important factor to consider is that carbon intensity is not CO₂ equivalent per tonne of fuel consumed, but instead CO₂e/MJ. This means that the goal of bunkering departments should be to find alternative fuels with high calorific value, low carbon intensity, and naturally at the lowest cost for the resulting carbon intensity reduction.

The consequences of non-compliance with the requirements will entail a penalty for the differences between required and

actual GHG intensity, multiplied by the energy used on applicable voyages. The penalty is currently EUR 2,400 per tonne of very low sulphur fuel oil (VLSFO) energy equivalent.

In a simplified example, this means that if a vessel only consumes VLSFO on EU voyages and 4% of the VLSFO is replaced, the vessel would normally consume a fuel with half of the GHG intensity and same calorific value, the price of the green fuel needs to be EUR 1,200 per tonne or less in order for this fuel type to be financially viable compared with paying the penalties. Here it is important to point out that for each year of non-compliance, the penalty is increased by 10%, so "paying to play" will soon become expensive.

Other ways to ensure compliance with FuelEU requirements include pooling of your vessels so that the pool's GHG intensity is below the limits and the possibility to borrow (with interest) from the following year's expected overcompliance.

There is also the concept of banking, i.e. 'lending' any overcompliance to the future. Unfortunately, in this case, no interest is given. However, it should motivate responsible parties to plan conservatively on overcompliance instead of risking penalties.

Pooling, banking or borrowing

There are several options for compliance with FuelEU Maritime. Some are simpler than others, but all come with an increase in reporting, data collection and verification requirements.

The first option is 'pay to play', in other words treating FuelEU Maritime penalties as a carbon tax and not considering ways to reduce your vessel's carbon intensity on voyages to, from and within the EU. This may make sense for some owners, and possibly be the only technically viable option for one-off voyages within the EU. However, the 10% annual increase in penalties should be borne in mind as a negative factor for this strategy in the long term.

The penalty amount (EUR 2,400 per tonne of HFO equivalent undercompliance) is set at a level which is intended to promote bunkering of low-carbon fuels. Therefore, this path to compliance will always be one of the most expensive in the long run. For example, a vessel consuming 1,000 tonnes of HFO on EU voyages in 2025 will be liable for a penalty of around EUR 59,000 in that year.

The second option is pooling non-compliant vessels with over-compliant vessels (though not ones that are exactly at compliance levels) to achieve pool compliance on an aggregate basis. This can be done with vessels in the same fleet or with the vessels of other owners/Document of Compliance holders, and the pool configuration can be changed every year.

This suggests that canny owners will be willing to trade into and out of pools with different marketplaces designed to accommodate different pool vessels from different owners. If this were to happen, it would

generate an overcompliance market where prices might vary.

In order to reach pool compliance between 2025 and 2029, 2.6% of the fuel mass consumed by the vessels could be replaced by e-methanol produced using energy from renewable resources. Another pathway to compliance would be to replace 3.2% of the fuel mass with B100 bio-diesel.

In order for the pathway using e-methanol to be cheaper than the penalties, the price would need to be less than EUR 2,250/tonne. For B100 to be cheaper, the price would need to be EUR 1,840/tonne or less. A deeper analysis can be made by comparing strategies which also incorporate the energy content of low-carbon fuels. Methanol for example has around half of the energy content per tonne compared with bio-diesel.

Owners also have the option of borrowing from expected future overcompliance in order to achieve their numbers. This hedge on future performance may be enough to give them more time to decide on their compliance strategy from 2026 onwards, though this option comes with a 10% interest rate.

The relatively small number of vessels fitted with wind-assisted propulsion can be subject to a GHG intensity reduction of up to 5%, which will keep vessels in compliance until the 6% limit is introduced in 2030 – though suppliers of such systems claim that actual GHG reductions can be considerably higher.

Practical compliance

The key issue for FuelEU Maritime is that reporting complexity will increase significantly when vessels need to keep track of

which fuels were consumed each day and by which consumer. This doesn't only involve the traditional method of reporting HFO, LFO etc, but makes it necessary to link each fuel consumed with a bunker delivery note (BDN).

For e-fuels and biofuels, reference to the Proof of Sustainability also needs to be reported so that verifiers can validate reported well-to-tank emissions. If that sounds complicated, then imagine for a minute the kind of accounting that would be necessary for blended fuels with different BDNs and well-to-wake emission factors.

Classification society DNV has put in the work to establish an updated "BDN-based" reporting method for their industry-wide Operational Vessel Data standard, together with associated guidelines. Coach will supply data in this format through our public API to emissions verifiers for all of our customers, ensuring that the excel-wizards are assigned to other tasks.

The noon report validations we perform are finely attuned with verification providers and this process will continue with the new requirements. This will ensure that operators can quickly pull statements for voyages and time periods. For vessels which do not require verified periodic emission statements during the year, provision of validated data to owners ensures that they are not making critical decisions based on guesses.

The aim is to create a single source of truth. The data reported and validated in our systems will not need manual checking and corrections, ensuring that shipping companies can concentrate on doing what they do best and use the data we provide for deciding on pathways towards compliance.



**WORLD
PORTS
CONFERENCE
2024**

REGISTRATION NOW OPEN

8-10 October 2024 | Hamburg, Germany

A world-class in person event in Hamburg bringing together leading port stakeholders for learning, information sharing, networking and collaboration



International Association of Ports and Harbors

Host sponsor:





magazines|events|online

visit: worldportsconference.com
 contact: +44 1329 825335
 or email: wpc@mercatormedia.com

Platinum sponsor: 

Gold sponsor: 

Silver sponsors:   

Bronze sponsors:    

Emissions monitoring system now integrated with Veracity

CLOUD PLATFORM | Engine maintenance and performance specialist, Chris-Marine AB, has announced a strategic partnership with Veracity by DNV. This is the classification society's independent cloud platform and digital marketplace designed to support key industries in using data to improve performance and gain access to online services. The Swedish company has now integrated its Trust-Ocean, a performance and monitoring system that collects onboard sensor data, with DNV's Veracity.

The partners are aiming to ensure that customers can be assured of the very best emissions data from their assets. This has become increasingly important with the entry into force of the EU Emissions Trading System and, from next January, FuelEU Maritime.

Chris-Marine's CEO, Jens Groth, commented: "Integrating Trust-Ocean with DNV's maritime emissions cloud, Verac-

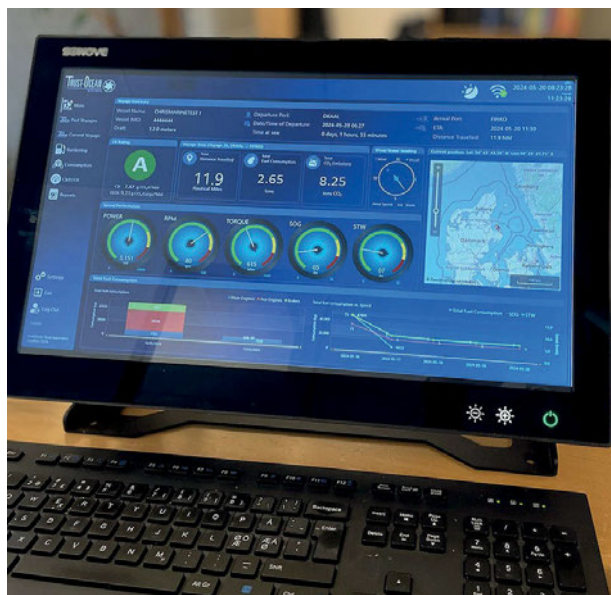

The performance and monitoring system, Trust-Ocean, has now been integrated with DNV's Veracity Source: Chris-Marine

ity, reduces the risk of low-quality data and improves data transparency. This enhances sustainability for our customers, supports

their decision-making process, and helps them achieve compliance and operational efficiency goals."

Trust-Ocean project leader, Aymen Abdaoui, said: "Trust-Ocean represents a significant advancement in maritime performance and monitoring technology. By automatically collecting data from onboard sensors, Trust-Ocean minimises manual processes and enhances data accuracy, saving time and effort for the crew.

"Our system features dynamic dashboards for real-time monitoring of vessel operational efficiency," he continued, "actively engaging the crew on board to take immediate and informed actions. Through our centralised platform, ship data is transmitted to the shore, stored in the cloud, and analysed via a secure web-based application, offering deeper insights and analytics."

Shippers offered book-and-claim sustainable fuel option

LBM | Gothenburg-based international transport and logistics company, Greencarrier, is offering its customers the opportunity to switch to zero-emission ocean freight on all of its routes, regardless of the vessel used for transport. The company's book-and-claim system is based on the amount of energy required to transport the specific cargo on a certain route and is an option that is available on bookings and routes within the entire group, the company said. The fuel, liquid biomethane (LBM), is certified by International Sustainability and Carbon Certification and contains no feedstocks from the palm oil industry. It is an established sustainable marine fuel that

can be net-zero depending on the feedstock used.

The gas is produced from sustainable biomass feedstocks such as industrial and agricultural waste streams that do not compete with food production and are widely available in Europe, Asia, and North America. The gas is upgraded and distributed to terminals where it is converted into liquid form before being made available as fuel for ships. Standards are regionally defined by the EU (RED II) in Europe, for example, and the Environmental Protection Agency (EPA) Renewable Fuel Standards in the United States.

The new fuel option has been developed by Greencarrier in collaboration with STX

Group which describes itself as an environmental commodity trader and a climate solutions provider. Shippers receive proof of the sustainable fuel purchase and an independently verified certificate on the real carbon dioxide reductions.

Greencarrier's head of Sustainability, Patrik Westraeus, said: "We are very pleased to offer our customers this opportunity. Through the simplicity of our offer, we create the conditions for increased use of biofuels and thus take an important step towards fossil-free shipping. This is entirely in line with our ambition to be one of the market's most sustainable logistics options."

Latest analytical models deliver substantial benefits

REPORT | Lloyd's Register's in-service product manager, Jim Smith, explains how data-driven maintenance analytics and real-time monitoring can significantly reduce costs for shipowners, whilst enhancing safety and supporting environmental sustainability.

Partners release report

In the constantly evolving landscape of maritime operations, ensuring the optimal performance and safety of vessels is paramount. Traditional maintenance practices, primarily based on running hours or scheduled activities, often fall short in addressing the real-time needs and conditions of onboard equipment. This is where data-driven condition-based maintenance has a role to play. By leveraging advanced data analytics and real-time monitoring, data-driven maintenance can reduce operational expenditure, enhance safety, and promote environmental sustainability.

Lloyd's Register (LR), NYK Line and Monohakobi Technology Institute (MTI) recently released a report detailing how data-driven maintenance processes that use the latest analytical models can deliver substantial benefits to maritime stakeholders plus the potential pathways to their successful implementation and the obstacles that must be navigated.

The report points to four challenges that shipowners must address to maximise the benefits of condition-based maintenance. These are a lack of precision in maintenance and inspection checklists; deviations from scheduled maintenance and inspections; vague or undefined criteria when identifying hazardous operating conditions; and ensuring an effective strategic response when faced with system failures.

Reducing opex

One of the most appealing advantages of data-driven maintenance is the potential to make significant savings in operational expenditure (opex). Traditionally, maintenance activities are scheduled based on predefined intervals or running hours, which does not account for the actual condition of the equipment. This can lead to unexpected failures, incurring

substantial costs as well as unnecessary maintenance.

Data-driven methods offer a solution to this challenge by uncovering trends and early warning signs of unsafe operating conditions. By analysing operational data, shipowners can proactively identify potential system failures and take preventive measures to mitigate risks.

Better knowledge of the equipment's condition allows maintenance activities to be targeted at the right time. This cuts the costs associated with unplanned downtime, such as increasing speed to meet berthing schedules, procuring spare parts urgently, and the associated logistical challenges.

Enhancing safety

Scheduled maintenance activities, when planned properly, are relatively safe. However, unplanned maintenance or failures often occur under less controlled conditions, increasing the potential hazards.

For example, performing maintenance while the vessel is in motion or under time pressure can lead to accidents. Data-driven maintenance helps to ensure that maintenance is performed when it is most safe and convenient. The increasing public visibility of incidents that occur at sea, and the consequent risks they carry for company reputations, mean that maritime operators can benefit from being seen to be adopting the latest technologies to enhance equipment safety.

Regulators and insurers are also showing an increasing interest in data-driven maintenance procedures. They see this as a means of providing transparency in compliance processes and reducing the risk of failures in service, delivering improved confidence in vessel operations and a reduction in insurance claims.

Environmental sustainability

With global goals to reduce emissions driving requirements for more efficient vessel operations, data-driven maintenance can help to reduce fuel consumption and emissions by supporting greater efficiency in the operation of machinery. It also means that maintenance can be carried out at the most convenient times.

Optimised maintenance can also help reduce the carbon footprint of the spare parts and maintenance logistics activities required to service a vessel. Traditional planned maintenance typically results in the provision and storage of many spare parts, some of which often remain unused beyond their expiry date. Optimised maintenance schedules will also minimise travel hours for service engineers and technical personnel attending to equipment and systems for testing and troubleshooting.

Integration and return on investment

Implementing data-driven maintenance requires an initial investment in technology and training, but the return on investment can be significant, as illustrated in our report. The key to successful integration lies in the seamless incorporation of data-driven techniques into existing maintenance workflows and systems.

The report is a call to the industry to collaborate on working towards achieving the economic, environmental, and safety benefits of data-driven, condition-based maintenance. As more data is collected and analysed, the predictive accuracy of data-driven maintenance improves, further increasing its value.

By embracing data-driven approaches and investing in advanced technologies, shipowners can usher in a new era of proactive maintenance in the maritime sector.



Source: Lloyd's Register

Cover of the report

New antenna ensures uninterrupted service

AUTOMATIC SWITCHING | Cobham Satcom has launched a new maritime satellite TV antenna designed for cruise ships and large yachts. The 3.7m Sea Tel 370s TV incorporates an automatic C-band switching function between circular and linear polarisation. This ensures uninterrupted viewing and continuous availability of live television such as ESPN, one of the most popular cruise ship channels, especially when major sporting events are taking place, the company said.

The advanced switching function on the new Television Receive only (TVRO) antenna means that ship operators no longer have to deploy an engineer to board the ship and manually change antennas between circular and linear polarisation. Until now, this time-consuming and costly process has been necessary when vessels enter a new region served by incompatible satellites. A further upgrade prevents the

recent phenomenon of 5G interference with satellite TV on board when ships are close to land.

Cobham Satcom intends to offer a feed upgrade which will be compatible with many



The new maritime satellite TV antenna designed for cruise ships and large yachts

Source: Cobham Satcom

existing Sea Tel 2.4-m and 3.7-m TVRO antennas already installed on cruise ships and yachts. This will save money and time for owners and operators.

The company's VP and product line director, Maritime, Henrik Fyhn, said: "While the ability to deliver high quality television on board is a key factor in guest satisfaction scores in the cruise sector, removing the need for regular engineer visits to manually modify an antenna for ships traversing between incompatible satellite regions, can deliver at least six figure savings over the lifetime of a vessel."

The latest TVRO launch follows a similar move in May when the company released its new Sailor XTR TVRO. Comprising 1-m and 1.2-m systems, this antenna series is designed with a smaller footprint and is suitable for a wide range of vessel types, the company said.

AI functionality added to voyage optimisation platform

SEANAVIGATOR | Japan-headquartered Weathernews Inc has added two new features to its cloud-based SeaNavigator voyage optimisation software. Two new AI tools, the Berth Waiting Forecast for ship operators and the New Tonnage finder for charterers were recently unveiled at a customer networking event in Copenhagen.

The Berth Waiting Forecast uses AI predictive data to enhance voyage efficiency and reduce emissions by enabling clients to tackle the challenge of port delays resulting from bad weather, and downtime from disrupted cargo handling. The system uses real-time ship status and congestion forecasts up to one week ahead and integrates AIS data from more than 70,000 ships. Weather data and historical delay comparisons are used to optimise voyage plans and adjust speed.

Waiting time is estimated by analysing ships clustered within the company's predefined port boundaries and calculated from average weekly values over the preceding month. A map zoom function provides a detailed visualisation of ships in the area.

Meanwhile, the New Tonnage Finder is designed to help charterers pick the best-performing vessels by using real-time data, ship performance models, AIS data, and weather and hydrographic data. The system uses four parameters: good weather average speed; good weather current factor; good weather performance speed; and good weather fuel consumption. By combining the parameters in various ways, a ship's performance speed can be ascertained and an AI model is then used to estimate fuel consumption based on vessel characteristics.

Weathernews' director EU Business Development, Niels Christian Kjærgaard, said: "These two new tools enhance SeaNavigator where every competitive advantage counts, not only in terms of minimising logistics risk, but also operational costs and environmental impact. They enhance the already impressive predictive capabilities of the platform which include the Voyage Planner and CII Simulator."

The company's new European CEO, Craig West, pointed out that increasing regulation and stakeholder influence will drive the need for improved efficiency, lower emissions, greater optimisation and visibility, more transparency, and reporting of Scope 1-3 emissions. He noted that increased operational risks owing to extreme weather events pose a further challenge, requiring an enhanced risk profile, advanced and revised modelling, and real-time notification procedures.



smm-hamburg.com

the leading international
maritime trade fair

driving the maritime transition

3-6 sept 2024
hamburg

buy a ticket
or redeem
your invitation

smm-hamburg.com/ticket



 Hamburg
Messe + Congress



 smm-hamburg.com/news

 linkedin.com/company/smmfair

 facebook.com/SMMfair

 youtube.com/SMMfair



ABB has introduced Optimal Speed Routing to help vessels enhance fuel efficiency and reduce emissions

Speed routing service launched

ROUTE GUARD | Swedish-Swiss technology company, ABB, has launched a new weather routing service, Optimal Speed Routing, that will support decision-making on ships' routes and speeds, thereby minimising voyage costs, fuel burn, and emissions. The new feature is included in the ABB Ability™ Routeguard onshore routing service and follows the company's acquisition earlier this year of the shipping business of DTN Europe BV and DTN Philippines Inc.

Launch of the new service comes as a growing number of marine sustainability specialists, including weather companies, highlight the importance of weather routing to avoid unfavourable conditions which can radically increase fuel consumption and emissions in unfavourable circumstances. They also point out that arriving at a destination port 'just-in-time' makes eminently good sense, rather than using more fuel by arriving early and then waiting for a berth.

ABB's Optimal Speed Routing provides advice to operators on changes they

should make to a ship's track or speed to avoid heavy weather. This is now part of overall calculations made within the Routeguard system addressing route optimisation. Variables used in the analysis include latest weather data and inputs including daily hire rates, fuel costs, and performance models to assess the relative merits of slowing down to let bad weather pass, or speeding up to avoid it.

Osku Kalkäjä, ABB Marine & Ports' head of Digital Business, said: "Optimal Speed Routing is an exciting addition to our digital offering, and we are grateful to our esteemed new colleagues who joined us recently and brought with them the Routing Services portfolio."

The company's product manager, Routing Services, Jarco van den Brink, noted: "Adding our Routing Services portfolio to ABB's existing digital services is a major milestone and we look forward to further opportunities to complement the offering and keep supporting our customers."

Tie-up for better procurement

LUBRICANTS | Closelink GmbH, a marine lubrications procurement company based in Hamburg, has announced a new tie-up with Norwegian fleet monitoring technology company, Navtor. The new arrangement means that lubricant stocks remaining on board (ROB) ships will be tracked by Navtor's stock reporting systems with data transferred directly into Closelink's procurement platform.

This will provide ship managers with a new tool to improve lubricant procurement planning and generate cost savings, the companies said. Benefits will include eliminating the need for last-minute purchases which are often more expensive, reducing the risk of product shortages, and ensuring the ordering of lubricants at the most favourable ports and outlets.

Lubricant stocks will be automatically updated and monitored so that ROB information is instantly available, thereby reducing manual entry errors and saving time. The new setup will give technical superintendents and purchasing personnel immediate access to essential information whenever it is needed. Closelink's procurement platform will bring together vessel schedules, supplier contracts, and ROBs, enabling users to plan and evaluate their options efficiently, always in accordance with current and future stock levels.

Closelink CEO, Philippe Lavarde, commented: "Data sharing in shipping benefits all stakeholders, improving operational efficiency, and enhancing decision-making processes. By integrating Navtor's data, we equip Eagle Bulk and other mutual customers with the information they need to make the right decisions, ultimately driving tangible cost savings."

Jacob Clausen, Navtor's performance director, said: "We are thrilled to partner with Closelink, a company that shares our commitment to innovation in the industry. This integration underscores the value of high-quality data and its ability to enhance operations for maritime professionals in all sectors."

The two companies' teams were able to complete the integration in just ten days, enabling all current and future mutual clients of the two companies to benefit from improved lubricant procurement efficiencies.

› IMPRINT

PUBLISHER

DVV Media Group GmbH
Postbox 10 16 09, DE-20010 Hamburg
Heidenkampsweg 73-79, DE-20097 Hamburg
+49 40 23714 100

MANAGING DIRECTOR

Martin Weber

PUBLISHING DIRECTOR

Manuel Bosch
manuel.bosch@dvmedia.com

EDITORIAL STAFF

Editor-in-Chief
Kathrin Lau
+49 40 23714 237 | kathrin.lau@dvmedia.com

ADVERTISING

Advertising Sales
Jan-Michael Jasper
+49 40 23714 248 | jan-michael.jasper@dvmedia.com
Stephan-Andreas Schaefer
+49 40 23714 253 | stephan-andreas.schaefer@dvmedia.com
Technical Department
Vera Hermanns
+49 40 23714 293 | vera.hermanns@dvmedia.com

Advertising rate card:
No 69 valid from January, the 1st, 2024

ADVERTISING REPRESENTATIVES

Germany, Austria, Switzerland
Gerald Ulbricht
+49 6195 9769734 | Smart: +49 170 3859573
gerald.ulbricht.extern@dvmedia.com
Scandinavia
Örn Marketing AB
+46 411 18400 | marine.marketing@orn.nu
UK, Ireland, BeNeLux, UAE, Oman, Bahrain, Saudi Arabia, Kuwait
Richard Johnson
+44 1603 417765 | Smart: +44 7565 010217
richard.johnson.extern@dvmedia.com
Singapore/Indonesia/Vietnam
Marimark Pte Ltd., John Bodill
+65 6719 8022 | john.bodill@marimark.com.sg
China
Nana Wang
Cssc_704@cssmc.cn

SUBSCRIPTION/DISTRIBUTION

Director Sales + Marketing
Markus Kukuk
+49 40 23714 291 | markus.kukuk@dvmedia.com
Readers'/Subscribers' Service
+49 40 23714 260 | service@dvmedia.com

SUBSCRIPTION TERMS

Subscriptions may be terminated at the end of any subscription period. Ordering a subscription first applies to the agreed-upon period (term of contract). The subscription contract can be terminated in writing at the end of the base period. If there has been no termination at that time, the contract is extended and can be terminated at the end of the new base period. The publishers accept no liability if it is not possible to publish the magazine due to force majeure or any other cause beyond their control.

ANNUAL SUBSCRIPTION RATES

Abonnement
Germany and outside Germany EUR 184.00 (Germany: excl. MWST/VAT) per year.
Single copy
EUR 36.80 (incl. MWST/VAT).
GMT members receive the magazine within their membership.

PRINTING HOUSE

Silber Druck OHG, Lohfelden

COPYRIGHT

by DVV Media Group, Hamburg, Germany
It is not permitted to publish, distribute or reproduce any part of this magazine without the publishers' prior written permission. This prohibition extends, in particular, to any form of commercial copying, inclusion in electronic databases or distribution including electronic databases or distribution in any electronic format, such as CD-ROMs or DVDs.

ISSN: 2191-0057
Commercial register HRB Hamburg 7906

MEMBER



SHIP&OFFSHORE IS OFFICIAL ORGAN OF THE ASSOCIATIONS:



› ADVERTISERS

Ship&Offshore

Bachmann electronic GmbH, AUT-Feldkirch	19
DVV Media Group GmbH, DEU-Hamburg	05,39,BC
Fil-Tec Rixen GmbH, DEU-Hamburg	04
FURUNO Electric CO., Ltd., JPN-Nishinomiya, Hyogo	31
GEFO Shipping Group, DEU-Hamburg	09
Hamburg Messe und Congress GmbH, DEU-Hamburg	43,97
Headway Technology Group (Qingdao) Co., Ltd., CHN-Qingdao	27
HEICO Befestigungstechnik GmbH., DEU-Ende	21
IMES GmbH, DEU-Kaufbeuren	FC
Lehmann Marine GmbH, DEU-Seevetal-Hittfeld	11
Lloyd's Register EMEA, DEU-Hamburg	23
MAN Energy Solutions SE, DEU-Augsburg	IFC
Mercator Media Limited, GBR-Fareham	93
Messe Düsseldorf GmbH, DEU-Düsseldorf	00
NETZSCH Pumpen & Systeme GmbH, DEU-Waldkraiburg	33
Noris Group GmbH, DEU-Nuremberg	32
Oswald Elektromotoren GmbH, DEU-Miltenberg	13
Panduit Corp., ROU-Arad	15
PODSZUCK® GmbH, DEU-Kiel	74
REINTJES GmbH, DEU-Hamelin	25
RINA Germany GmbH, DEU-Hamburg	35
Steelpaint GmbH, DEU-Kitzingen	Flying Page
TGE Marine Gas, DEU-Bonn	34
VEGA Grieshaber Instruments GmbH, DEU-Schiltach	17
WAGO GmbH & Co.KG, DEU-Minden	20
Wilhelmsen Ships Service GmbH, DEU-Sittensen	37
Woodward L'Orange GmbH, DEU-Stuttgart	29

Ship and Offshore Repair Journal (SORJ)

Accelleron Turbo Systems Switzerland Ltd, CHE-Baden	46
Air Products GmbH, NOR-Kristiansand	49
Beşiktaş Shipyard, TUR-Şişli İstanbul	55
Bolidt Kunststoffoepassing BV, NDL-Hendrik-Ido-Ambacht	61
Detyens Shipyards Inc (Dsi), USA-North Charleston	53
Genova Industrie Navali S.p.A., ITA-Genova	65
HullWiper Ltd, UAE-Dubai	51
Link Instrumentation and Control Services, UAE-Dubai	52
Navantia, S.A, S.M.E., ESP-Cartagena	66
Randive Inc., USA-Cliffwood Beach	63
Remontowa Shiprepair Yard, POL-Gdansk	FC
RWO GmbH, DEU-Bremen	57
UMAR Shipping Services Ltd., CYP-Limassol	59
Energy at Sea	
Cuxport GmbH - Cuxport Terminal, DEU-Cuxhaven	83
GMT Gesellschaft für Maritime Technik e.V., DEU-Hamburg	89
Chr. Mayr GmbH + Co. KG, DEU-Mauerstetten	79
Stiftung Offshore Windenergie, DEU-Hamburg	76
Ystad Hamn Logistik AB, SWE-Ystad	81



Keep an eye on the **shipbuilding** market!

Subscribers
receive a
10% discount!*

Even more
professional
information – on
the **New Ships**
website!

New Ships

*After the trial period, the discount with the discount code **NSH10DVV** applies exclusively to orders by new customers for the first reference year. Thereafter the regular annual price will apply.

www.new-ships.net/testsubscription



STEELPAINT[®]

Long-lasting Corrosion Protection
for new Columbus-quay

Since autumn 2021 the new
»Columbuskaje« is being built in
Bremerhaven for around 80 mill. €.

The Company Steelpaint was
commissioned with the corrosion
protection of the structure
using their one-component,
moisture-cure polyurethane-
system on the Weser Port

The new Columbus quay
sheet pile wall
coated with Steelpaint
at ArcelorMittal
Luxembourg



**ALGOMA VERITY
SP-PUR-ZINCING**



**SP-PUR-ZINCING
FOR CARGO HOLDS**

New Building – Oldendorff Vessels
New Yangzijiang Shipyard, China



**MUUGA CARGO HARBOUR, ESTONIA
PORT FACILITIES**

SP-ZINCING
SP-COMBINATION
Piles coated in 2018,
Picture taken in 2022

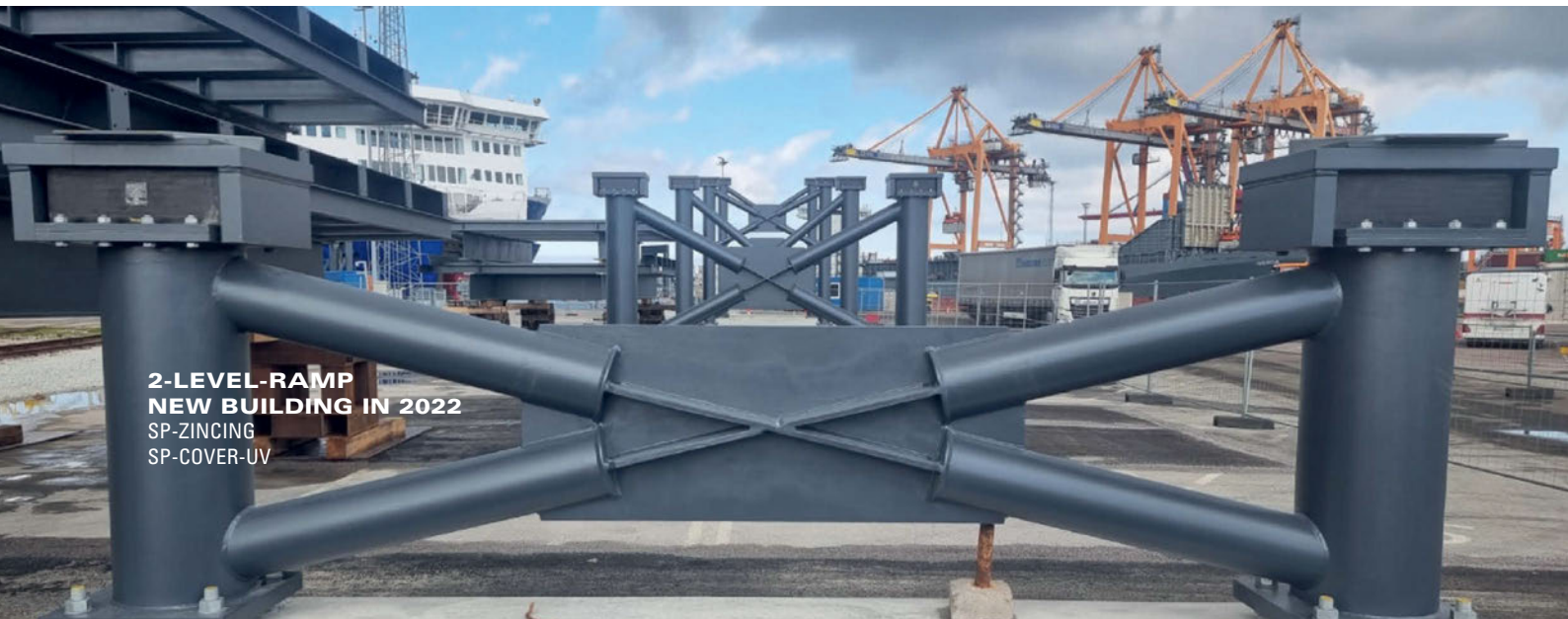

**2-LEVEL-RAMP
NEW BUILDING IN 2022
SP-ZINCING
SP-COVER-UV**



STEELPAINT

BREMERHAVEN PORTS
CONTAINER TERMINALS

**STEELPAINT-SYSTEMS with
STEELPAINT-PUR-ZINCING**
Better cathodic corrosion protection for highly
stressed areas on all types of vessels as well as port
facilities including container bridges



Please visit us at SMM
Hall B5, Stand 315

STEELPAINT GmbH
PO Box 231 · 97305 Kitzingen · Germany
Am Dreistock 9 · 97318 Kitzingen · Germany
phone +49 (0)9321 3704-0 · fax +49 (0)9321 3704-40
www.steelpaint.com · Email: mail@steelpaint.com